



FLOMAX 8

2" x 2" Self Priming Centrifugal Pump

FLOMAX® 8 self-priming centrifugal pumps are capable of creating vacuum sufficient to lift liquids from heights up to 25 feet above the source. Once primed, the pump's built in flapper valve will maintain a full column of liquid in the suction line.

A FLOMAX® 8 PumPAK® is a fully assembled and run tested pump end that can be easily coupled to a number of drivers such as hydraulic motors, 56C and 145TC frame motors and gas engines. A bearing pedestal is also available for T-frame motor or belt drive.

Standard features include stainless steel drive sleeve, stainless steel fasteners, renewable wearplate, and a semi-open dynamically balanced impeller.

The FLOMAX® series of pumps are commonly used in Industrial, OEM, Agricultural and Marine applications, such as: Bilge Pumps, Auxiliary Fire Pumps, Ballast Transfer Pumps, Washdown Pumps, Fertilizer and Pesticide Pumps, Applicators & Sprayers, Blending Pumps, Nurse Tanks, Bulk Transfer Pumps and much more.

ABS Type Approval for the Flomax 5 and 8 - [Download PDF](#)



Application

- Agricultural
- Industrial
- Marine
- OEM

Features

- Renewable wear plate
- Stainless steel drive sleeve
- Stainless steel fasteners
- Up to a 25' suction lift

SPECIFICATIONS:

Suction And Discharge	2" x 2" NPT
Materials Of Construction	316 stainless steel, Aluminum, Bronze, Cast iron
Flow	Up to 150 GPM
Head Feet	UP to 100'
Impeller	5.0" max. diameter, semi-open
Motor	Up to 3 HP
Drive Options	Close coupled 56C, Engine mount 5.5 HP, Engine mount 6.5 HP, Close coupled 145TC, Pedestal, PumPAK® (without motor)
Seal	Special seal material combinations available (consult factory), Standard carbon / ceramic / Viton
Options	5 blade impeller available for higher flows, Base plate shown above is optional, Double seal available for dry run applications, Flanges not included on S.S. models, Hydraulic motor .37 cu. in.,

FLOMAX 8

Hydraulic motor .45 cu. in., Hydraulic
motor .58 cu. in.

Max Solid Size

.56"



34800 BENNETT - FRASER, MI 48026-1686
(586) 293-8240 - FAX (586) 293-8469
(800) 563-8006 - www.mppumps.com

FLOMAX 8

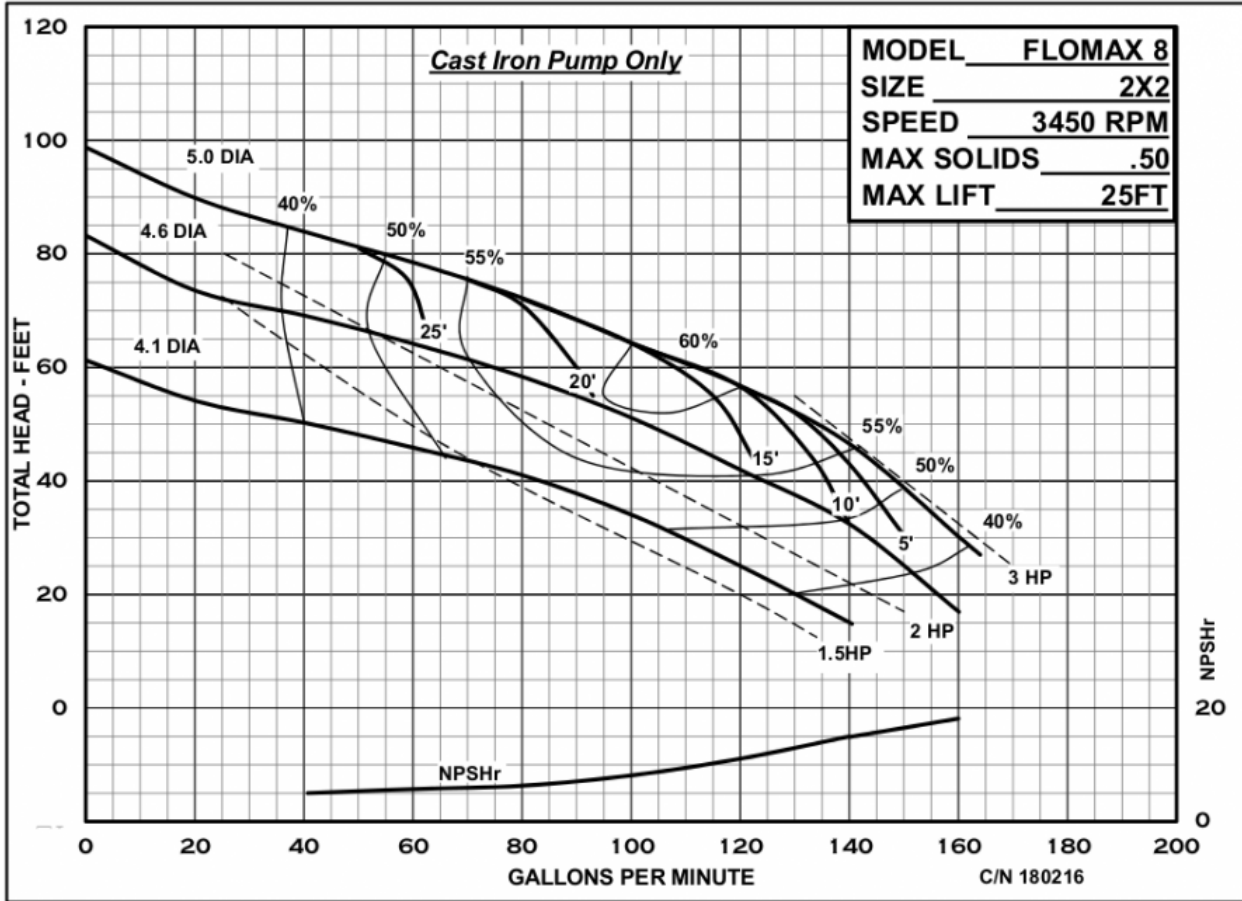

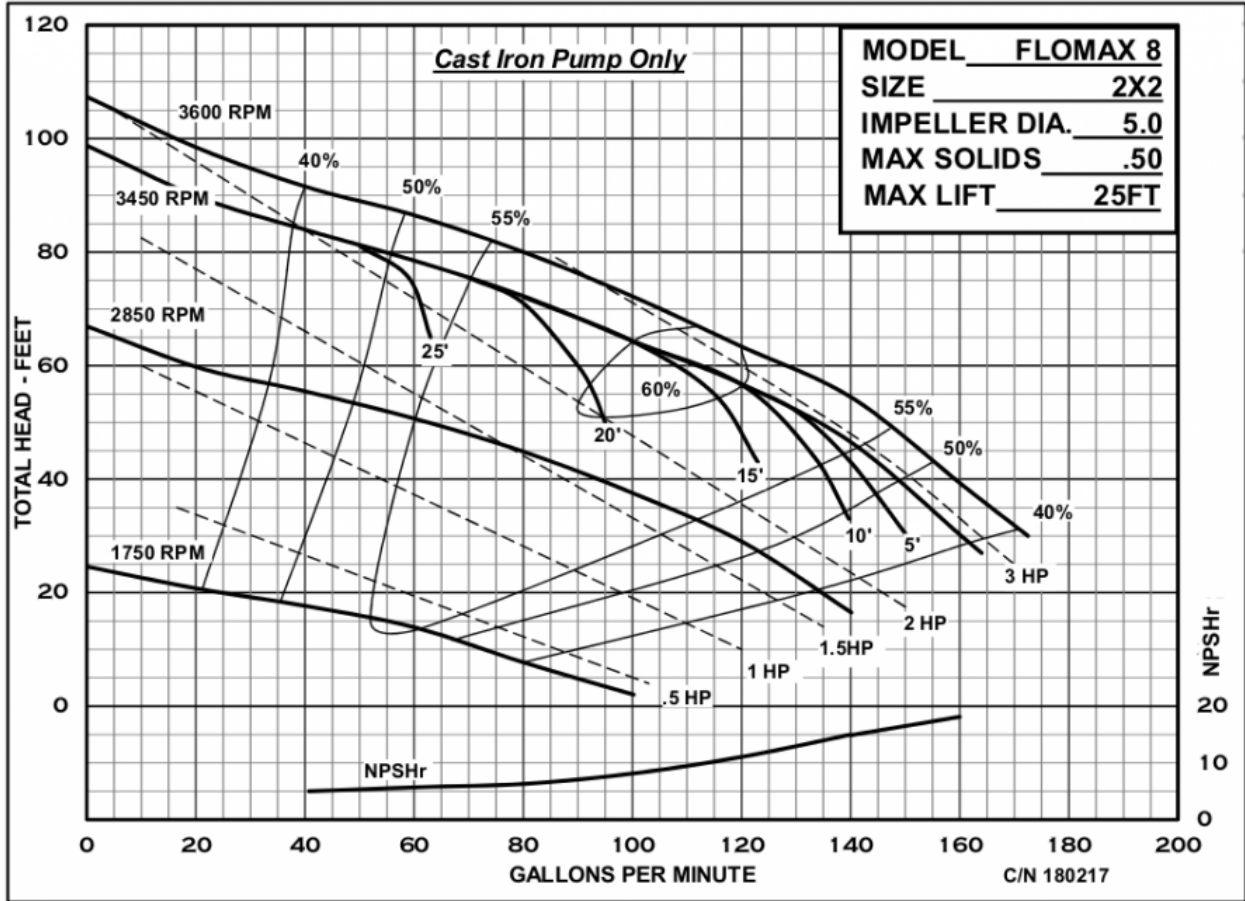

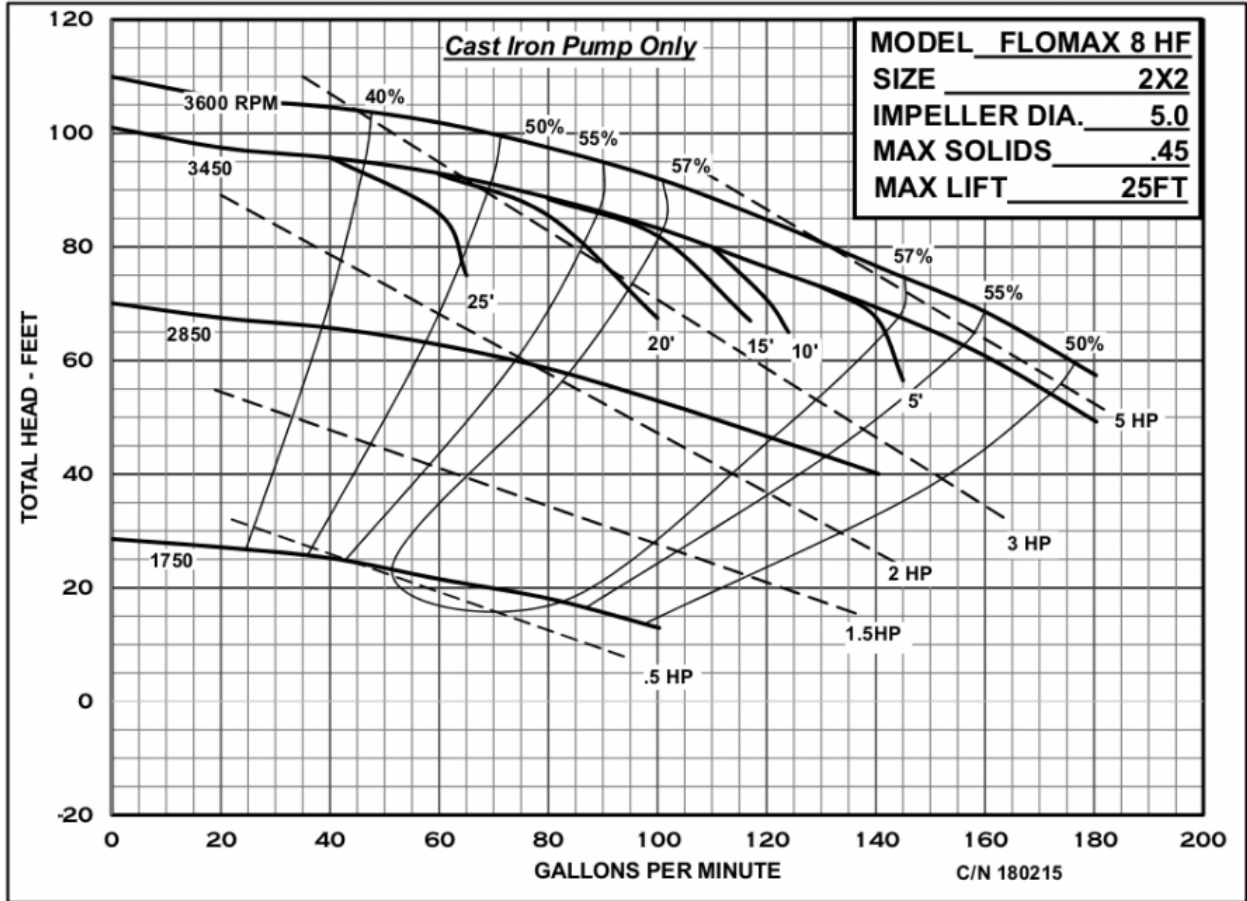

FLOMAX 8

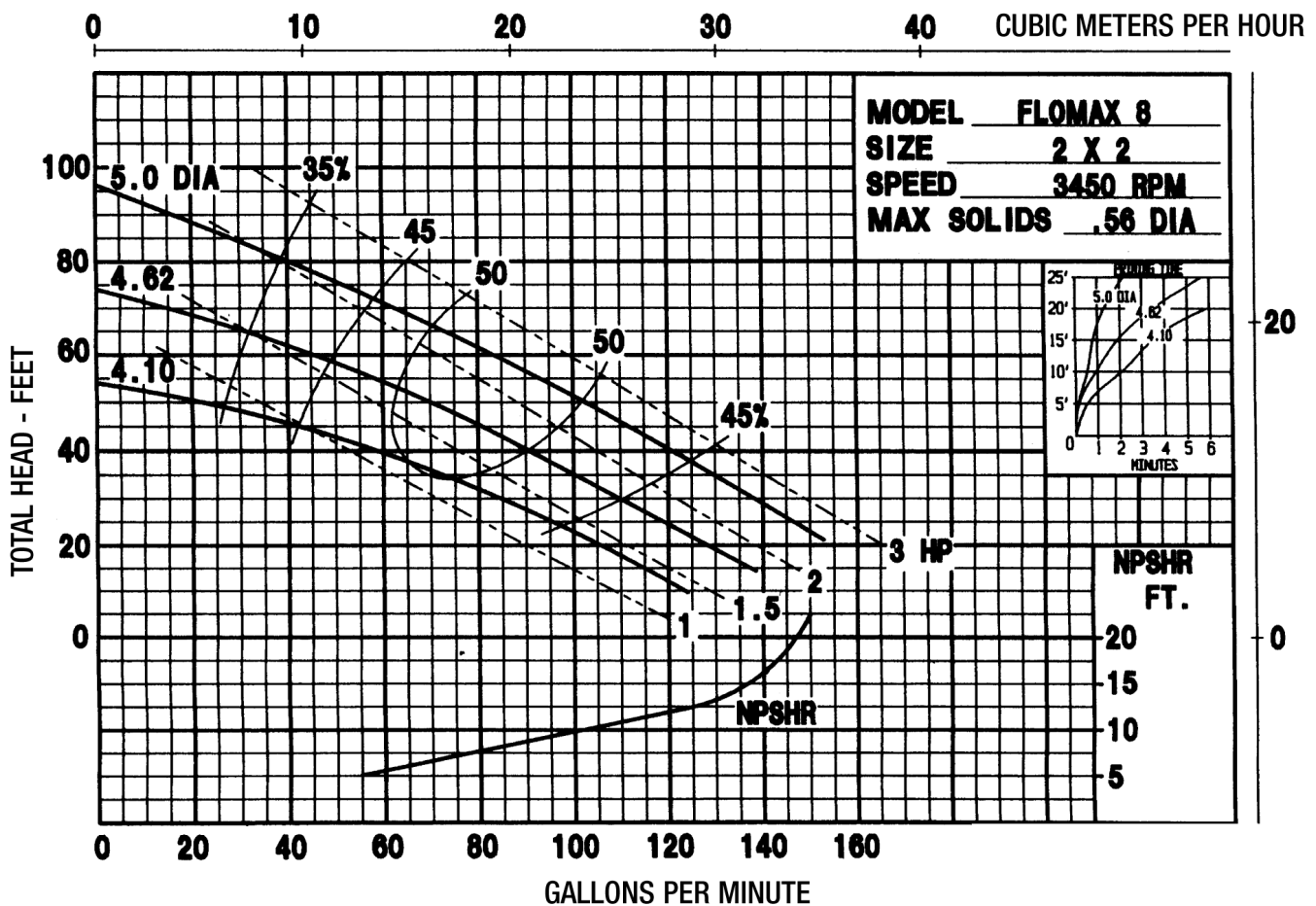
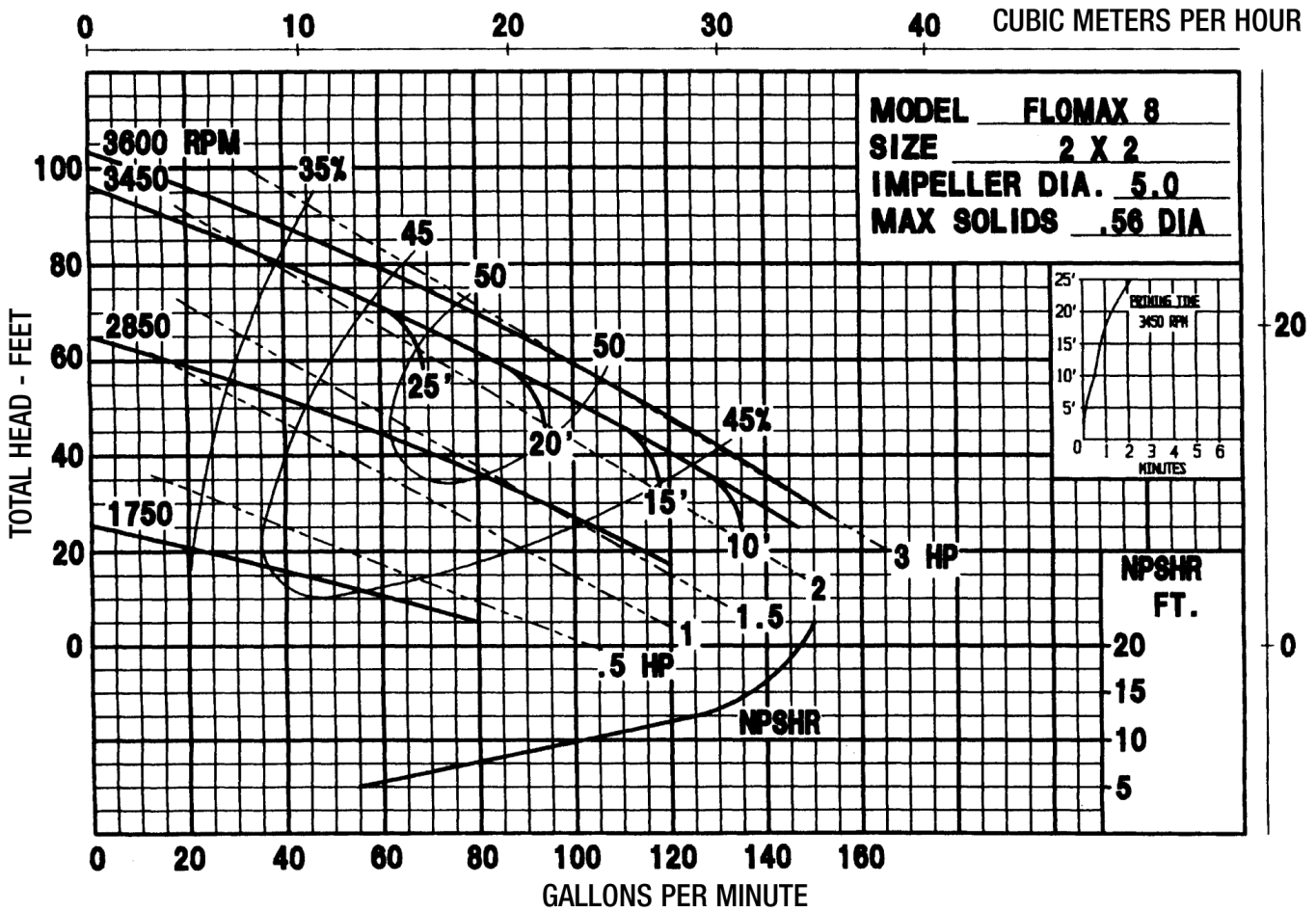

34800 BENNETT - FRASER, MI 48026-1686
 (586) 293-8240 - FAX (586) 293-8469
 (800) 563-8006 - www.mppumps.com

FLOMAX 8

CUBIC METERS PER HOUR

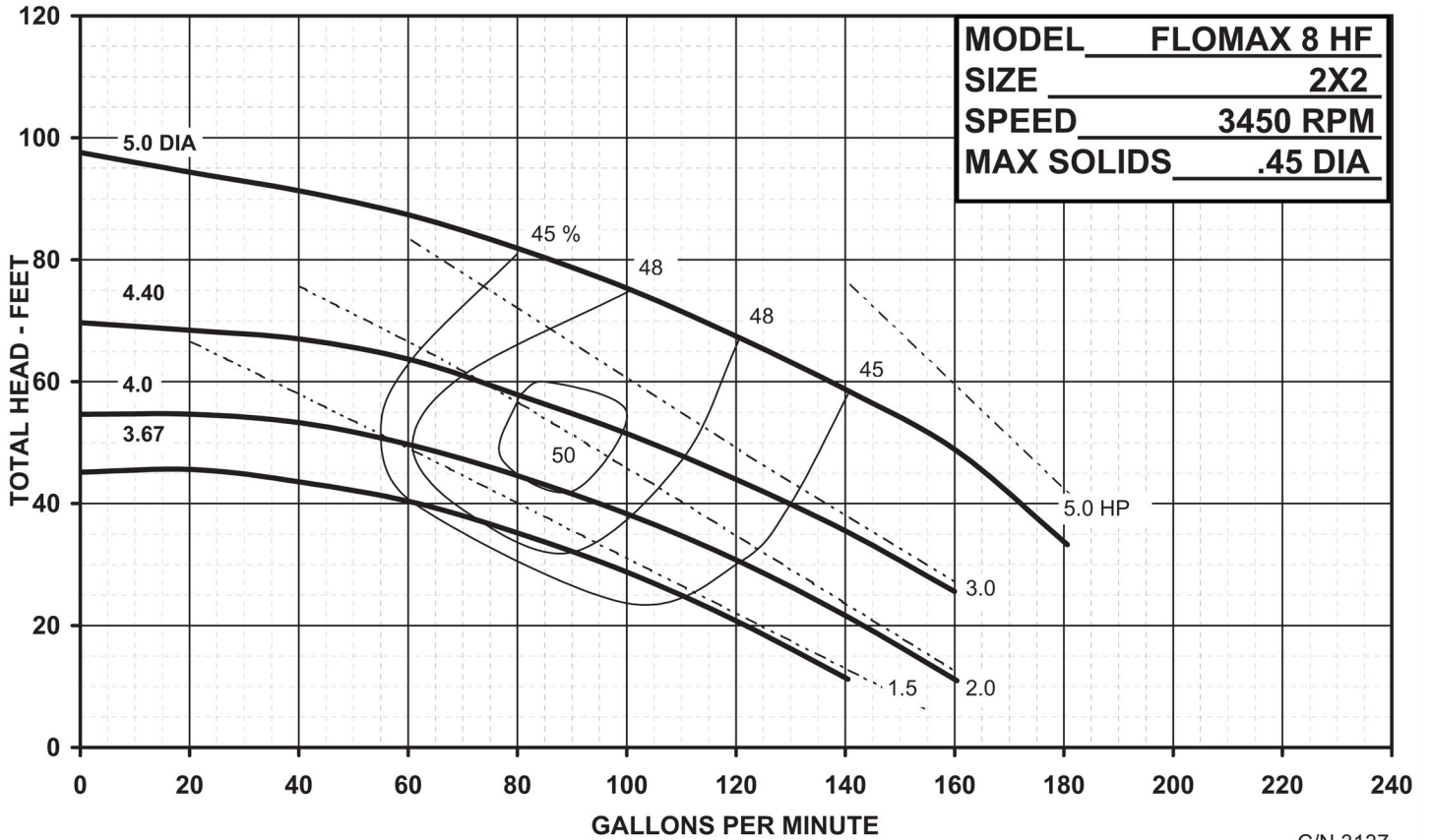
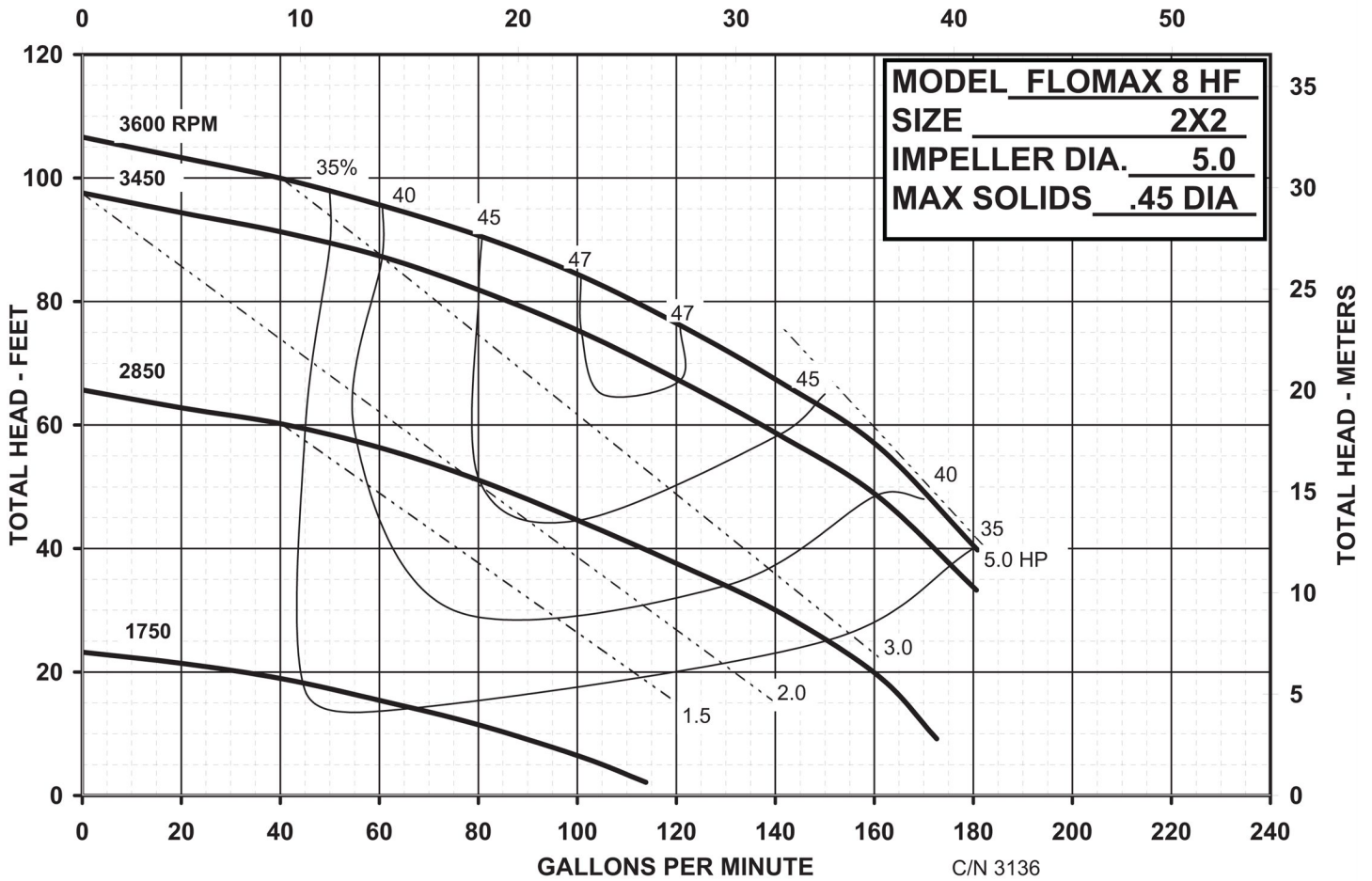

34800 BENNETT - FRASER, MI 48026-1686
 (586) 293-8240 - FAX (586) 293-8469
 (800) 563-8006 - www.mppumps.com

FLOMAX 8

FLOMAX 8

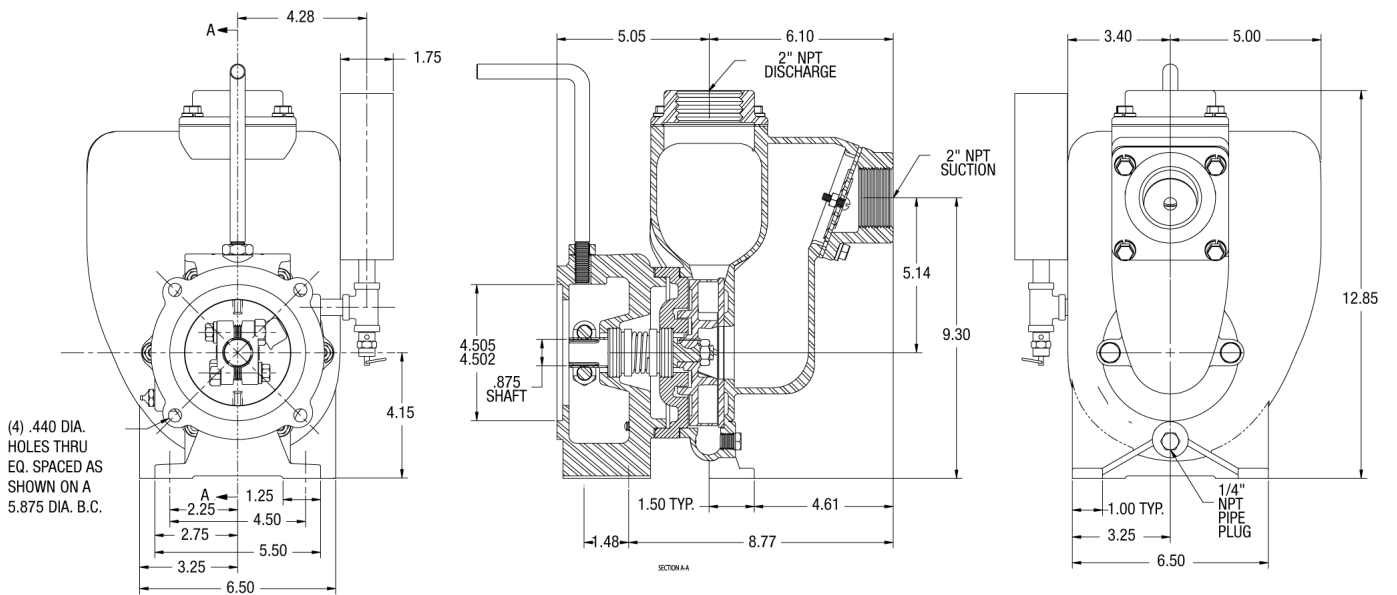
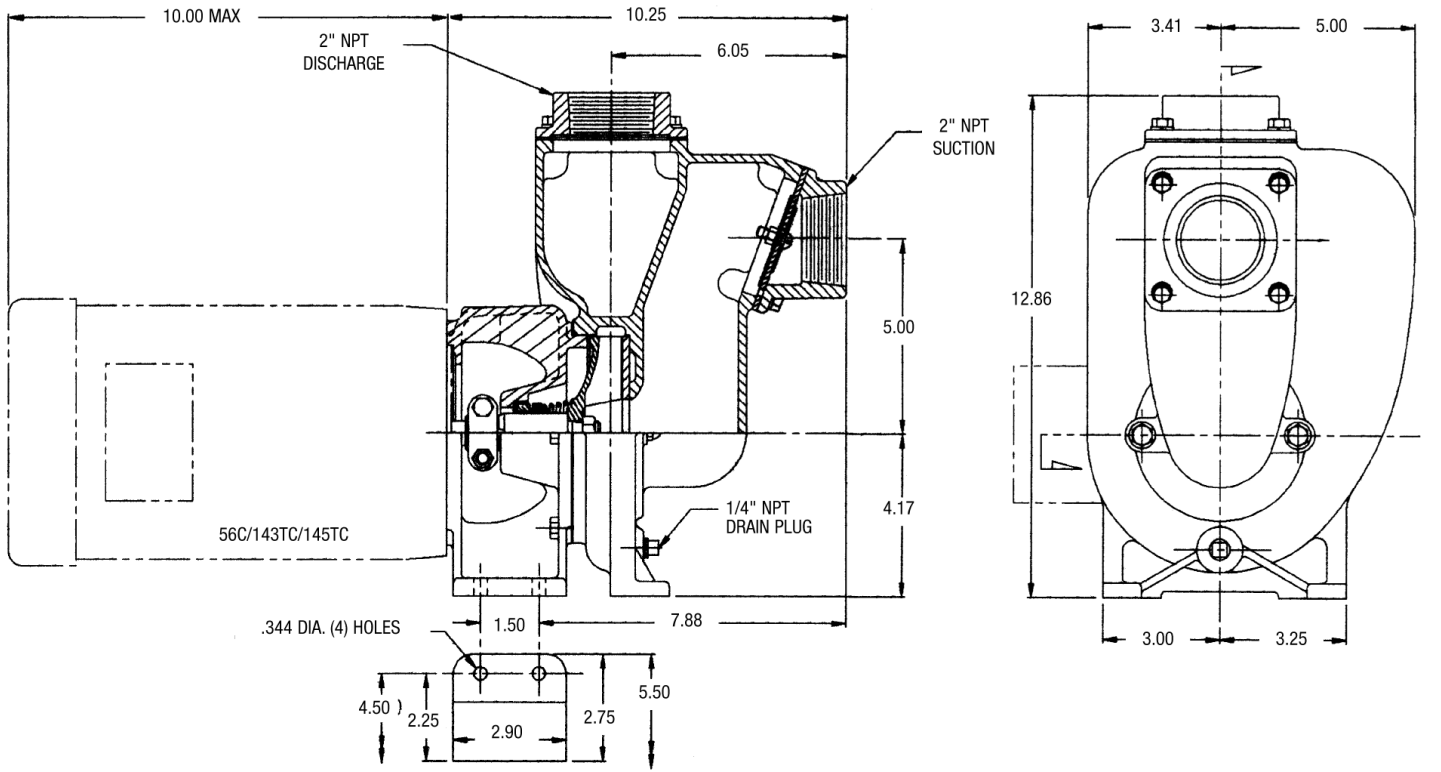

MP PUMPS SERVICE PARTS LIST

- Self Priming
- Electric Motor Drive
- Pumpak
- Close Coupled

Flomax 5 1 1/2" x 1 1/2" Pipe Size
Flomax 8 2" x 2" Pipe Size

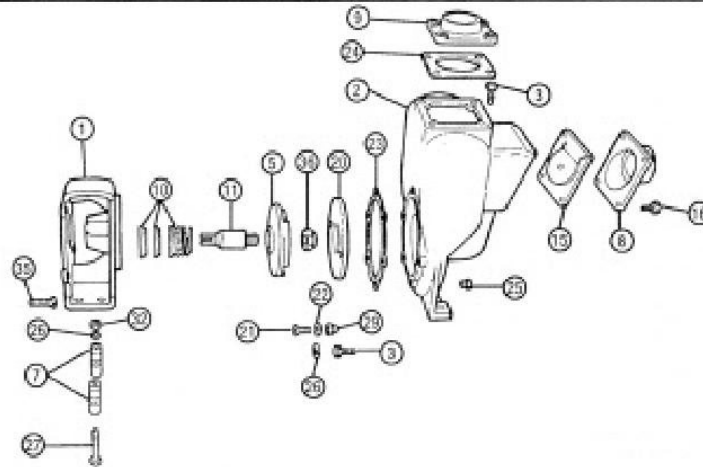

IMPORTANT: Read special instructions for item 10.
 When ordering parts, specify model and serial number shown on nameplate.
 N/S means not shown in exploded view of parts.

ITEM NO.	PART NO.	DESCRIPTION	QUANTITY REQUIRED PER MODEL							
			METAL		CAST IRON		ALUMINUM		BRONZE	
			FLOMAX		5	8	5	8	5	8
			MODEL NO.							
		7/8" sleeve		26074	25922	26262	26066	26268	26066	
		5/8" sleeve		25979	26079	26260	26264	26223	25984	

HOUSING

	23021	Housing Assembly Cast Iron — Incl.:		1	1				
2		Housing — Cast Iron		1	1				
3	24965	Capscrew — S.S. — 5/16" x 3/4"		6	6				
25	21267	Pipe Plug — 1/4"		1	1				
	32019	Housing Assembly R.H. Aluminum Inc.:				1	1		
2		Housing — Aluminum				1	1		
3	24965	Capscrew — S.S. — 5/16" x 3/4"				6	6		
25	21267	Pipe Plug — 1/4"				1	1		
	23020	Housing Assembly Housing — Bronze						1	1
2		Housing — Bronze						1	1
3	24965	Capscrew — S.S. — 5/16" x 3/4"						6	6
25	21267	Pipe Plug — 1/4"						1	1
16	21242	Capscrew — S.S. — 5/16" — Flanges	8	8	8	8	8	8	8
26	21238	Lockwasher — S.S. — 5/16" Housing to Suction — 4 Housing to Discharge — 4	8	8	8	8	8	8	8
15	23022	Flapper Assembly		1	1	1	1	1	1
23	22255	Gasket — Housing to Adapter		1	1	1	1	1	1
24	22256	Gasket — Outer to Housing		1	1	1	1	1	1

FLANGES

8	22263	Flange — Inlet — Cast Iron — 1-1/2"	1						
8	22287	Flange — Inlet — Cast Iron — 2"		1					
8	22261	Flange — Inlet — Aluminum — 1-1/2"				1			
8	22385	Flange — Inlet — Aluminum — 2"					1		
8	22262	Flange — Inlet — Bronze — 1-1/2"						1	



MP PUMPS, INC.

34800 BENNETT • FRASER, MI 48026-1686
 (586) 293-8240 • FAX (586) 293-8469
 (800) 563-8008 • www.mppumps.com

FORM 7052-F

PRINTED IN U.S.A. (8-97)

ITEM NO.	PART NO.	DESCRIPTION	QUANTITY REQUIRED PER MODEL						
			METAL	CAST IRON		ALUMINUM		BRONZE	
			FLOMAX	5	8	5	8	5	8
			MODEL NO.						
		7/8" sleeve	26074	25922	26262	26066	26268	26066	
		5/8" sleeve	25979	26079	26260	26264	26223	25964	

FLANGES - Continued

8	22386	Flange — Inlet — Bronze — 2"						1
9	22266	Flange — Outlet — Cast Iron — 1-1/2"	1					
9	22311	Flange — Outlet — Cast Iron — 2"		1				
9	22264	Flange — Outlet — Aluminum — 1-1/2"			1			
9	22309	Flange — Outlet — Aluminum — 2"				1		
9	22265	Flange — Outlet — Bronze — 1-1/2"					1	
9	22310	Flange — Outlet — Bronze — 2"						1

IMPELLER

5	22293	Impeller — Cast Iron — 5.0" Dia.	1	1				
5	24585	Impeller — Cast Iron — 4.6" Dia.						
5	25139	Impeller — Cast Iron — 4.1" Dia.						
5	22294	Impeller — Stainless Steel — (Optional)	1	1	1	1	1	1
5	22291	Impeller — Aluminum — 5.0" Dia.			1	1		
5	22292	Impeller — Bronze — 5.0" Dia.					1	1
35	22655	Impeller — Lock Nut — S.S. — 5"	1	1	1	1	1	1
11	22253	Drive Sleeve — S.S. 5/8" Bore For NEMA 56C	1	1	1	1	1	1
11	25664	Drive Sleeve — S.S. 7/8" Bore For NEMA 184C — 145TC — 143TC	1	1	1	1	1	1

CLAMP

	23002	Clamp Assembly, for 5/8" sleeve — 56C frame — Incl.:						
7		Clamp	1	1	1	1	1	1
27	21264	Capscrew — S.S. — 5/16"	2	2	2	2	2	2
32	21284	Hex Nut — S.S. — 5/16"	2	2	2	2	2	2
26	21238	Lockwasher — S.S. — 5/16"	2	2	2	2	2	2
	23003	Clamp Assembly — 7/8" sleeve — 18C — 145TC — 143TC						
7		Clamp	1	1	1	1	1	1
27	21264	Capscrew — S.S. — 5/16"	2	2	2	2	2	2
32	21284	Hex Nut — S.S. — 5/16"	2	2	2	2	2	2
26	21238	Lockwasher — S.S. — 5/16"	2	2	2	2	2	2

WEAR PLATE

20	23024	Wear Plate Assembly — Steel — Incl.:	1	1				
21		Wear Plate — Steel	1	1				
21	21249	Flat Head Screw — S.S. — 5/16"	2	2				
22	21248	Annular Gasket — 1/2"	2	2				
20	22270	Wear Plate Assembly — Aluminum — Incl.:			1	1		
21		Wear Plate — Aluminum			1	1		
21	21249	Flat Head Screw — S.S. — 5/16"			2	2		
22	21248	Annular Gasket — 1/2"			2	2		
20	22271	Wear Plate Assembly — Bronze — Incl.:					1	1
21		Wear Plate — Bronze					1	1
21	21249	Flat Head Screw — S.S. — 5/16"					2	2
22	21248	Annular Gasket — 1/2"					2	2
29	21237	Acorn Nut — S.S. — 5/16"	2	2	2	2	2	2

SEAL

Be sure you specify whether you want the self-lubricated seal or the grease-lubricated seal.

10	22272	Seal Assembly — Self-Lubricated — Incl.:	1	1	1	1	1	1
*10	22290	Seal Assembly — Grease Lubricated	1	1	1	1	1	1
	22313	Grease Cup N/S	1	1	1	1	1	1

ADAPTOR

1	25904	Adaptor — Cast Iron	1	1				
1	25946	Adaptor — Aluminum			1	1		
1	25948	Adaptor — Bronze					1	1
1	26181	Adaptor — Cast Iron — Grease Seal Assembly	1		1			
35	21251	Capscrew 5/16" — Adaptor To Motor	4	4	4	4	4	4
N/S	21238	Lockwasher 5/16" — Adaptor Motor	4	4	4	4	4	4

*Optional for special applications.

 MP PUMPS, INC. 34800 BENNETT • FRASER, MI 48026-1686 (586) 293-8240 • FAX (586) 293-8469 (800) 563-8008 • www.mppumps.com	FORM 7052-F PRINTED IN U.S.A. (8-97)
---	--

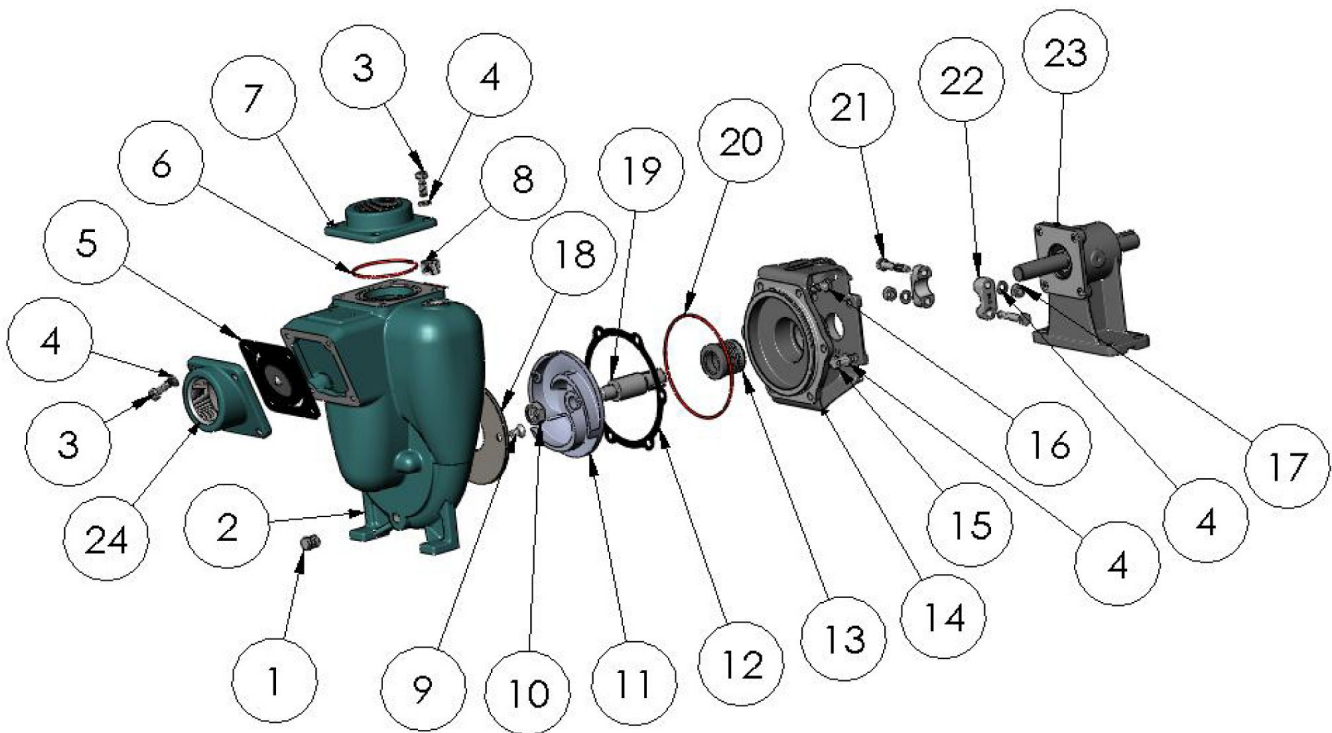

PART NO.	ITEM NO.	DESCRIPTION	QTY.	PART NO.	ITEM NO.	DESCRIPTION	QTY.
41475	1	PIPE PLUG - 1/4" NPT	2	* 22272	13	SEAL ASSY - T-2100 VITON	1
22251	2	HOUSING	1	22247	14	ADAPTER C.I.	1
21242	3	CAPSCREW - 5/16"-18 X 7/8	8	21278	15	CAPSCREW S.S. - 5/16-18 X .88	4
21238	4	LOCKWASHER - 5/16"	14	24965	16	CAPSCREW S.S. - 5/16-18 X .75 PATCH	6
* 23022	5	FLAPPER ASSY.	1	21284	17	HEXNUT S.S. - 5/16"-18	2
* 37141	6	O RING - VITON	1	* 22260	18	WEAR PLATE STL.	1
22311	7	DISCHARGE FLANGE - 2" NPT	1	22286	19	DRIVE SLEEVE S.S. - 3/4"	1
37140	8	FILL PLUG ZPS - 1/2" NPT	1	* 34555	20	O RING - VITON	1
37137	9	SCREW S.S. FHS - 5/16"-18 X .63	2	21264	21	CAPSCREW - 5/16"-18 X 1 3/4	2
22655	10	JAM NUT -S.S. - 5/8-18	1	21946	22	CLAMP S.S.	2
22293	11	IMPELLER C.I. - Ø5.00	1	26141	23	PEDESTAL ASSY. C.I. - H.D.	1
* 22255	12	GASKET - NI-2085	1	22387	24	SUCTION FLANGE C.I.	1

* SUGGESTED REPLACEMENT PARTS

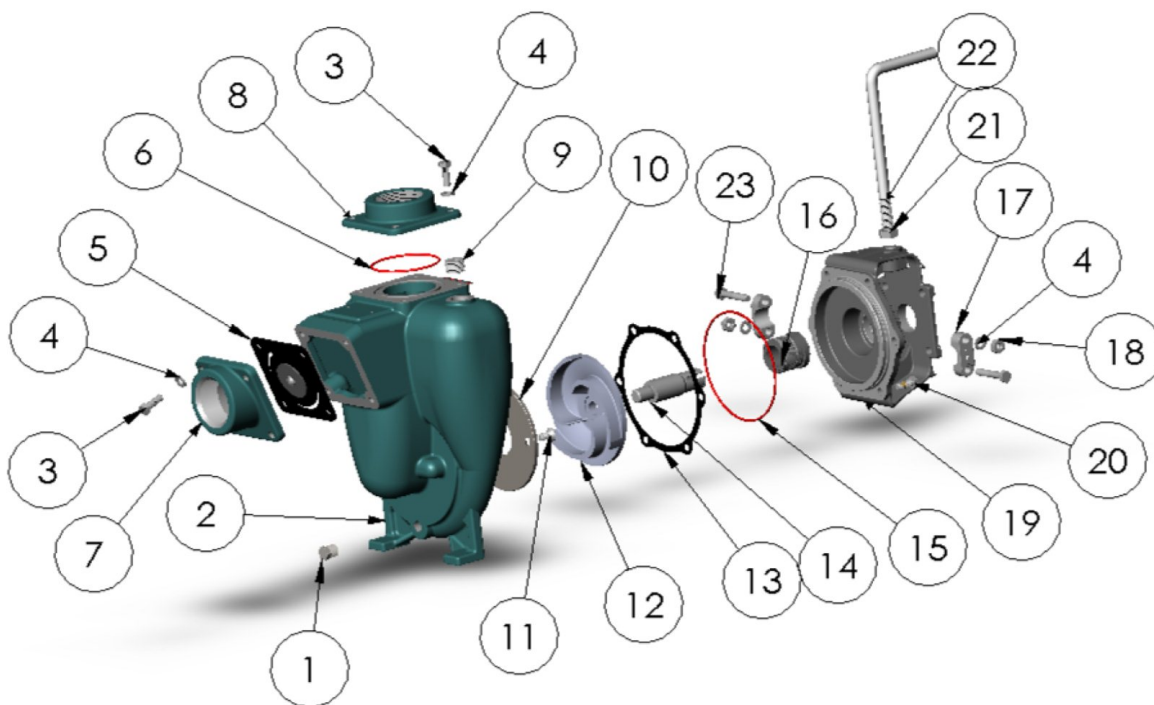

PART NO.	ITEM NO.	DESCRIPTION	QTY.	PART NO.	ITEM NO.	DESCRIPTION	QTY.
41475	1	PIPE PLUG - 1/4" NPT	1	22293	12	IMPELLER C.I. - Ø5.00	1
22251	2	HOUSING C.I.	1	* 22255	13	GASKET - NI-2085	2
21242	3	CAPSCREW S.S.- 5/16"-18 X 7/16	8	22286	14	DRIVE SLEEVE S.S - 3/4	1
21238	4	LOCKWASHER S.S.- 5/16"	10	* 34555	15	O RING - VITON	1
* 23022	5	FLAPPER ASSY. - BUNA	1	* 22272	16	SEAL ASSY T-21 00- VITON	1
* 37141	6	O RING - VITON	1	21946	17	CLAMP	2
22311	7	DISCHARGE FLANGE - 2" NPT	1	21284	18	HEXNUT - 5/16"-18	2
22387	8	SUCTION FLANGE - C.I.	1	22247	19	ADAPTOR C.I.	1
37140	9	FILL PLUG - 1/2" NPT	1	24965	20	HEX HEAD SCREW S.S. - 5/16-11	6
* 22260	10	WEAR PLATE STL.	1	22637	21	HEX JAM NUT STL. - 1/2-13	1
37137	11	SCREW S.S.- 5/16"-18 X .63	2	21938	22	HANDLE STL. - 10.25 LONG	1
				21264	23	HEX HD. CAPSCREW S.S.	2

* SUGGESTED REPLACEMENT PARTS

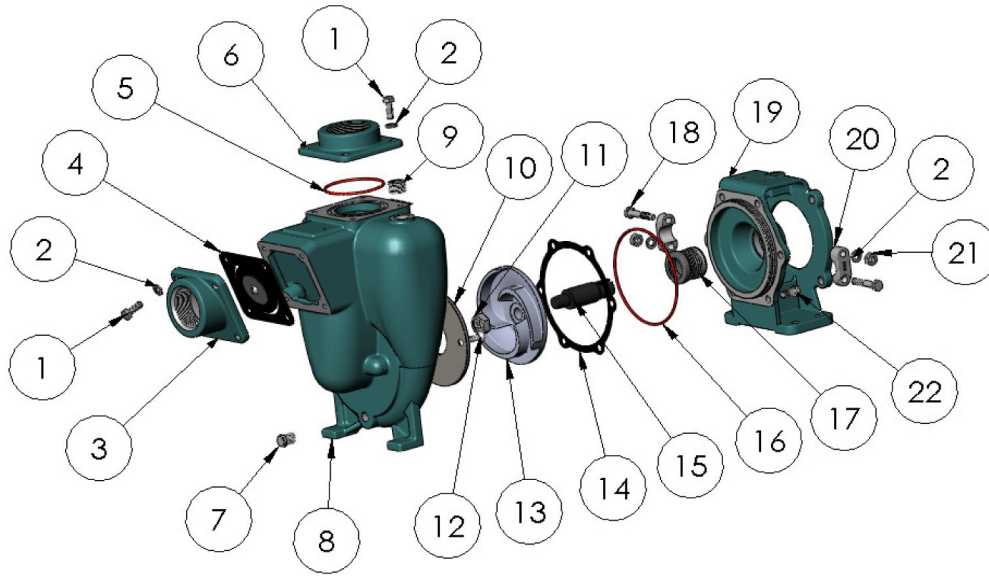

ITEM NO.	PART NO.	DESCRIPTION	QTY.		ITEM NO.	PART NO.	DESCRIPTION	QTY.
1	21242	CAPSCREW S.S. - 5/16"-18 X 7/8"	8		13	22293	IMPELLER C - Ø5.0	1
2	21238	LOCKWASHER S.S. - 5/16	10	*	14	22255	GASKET - NI-2085	1
3	22387	SUCTION FLANGE C - 2" NPT	1		15	22253	DRIVE SLEEVE S.S. - 5/8	1
* 4	23022	FLAPPER ASSY - BUNA	1	*	16	34555	O-RING - VITON - AS-568-158	1
* 5	37141	O-RING - VITON	1	*	17	22272	SEAL ASSY. - T-2100 VITON	1
6	22311	DISCHARGE FLANGE B - 2" NPT	1		18	21264	CAPSCREW- 5/16"-18 X 1 3/4"	2
7	41475	PIPE PLUG STL. - 1/4" NPT	1		19	25904	ADAPTER C - CC MOTOR	1
8	22251	HOUSING C	1		20	21946	CLAMP S.S. - 3/4 & 5/8 SL	2
9	37140	FILL PLUG ZPS - 1/2" NPT	1		21	21284	HEX NUT S.S. - 5/16 -18	2
* 10	22260	WEAR PLATE STL.	1		22	24965	CAPSCREW- 5/16"-18 X 3/4" - PATCH	6
11	22655	JAM NUT S.S. - 5/8"-18	1					
12	37137	SCREW SS - 5/16"-18 X 5/8"	2					

* SUGGESTED REPLACEMENT PARTS

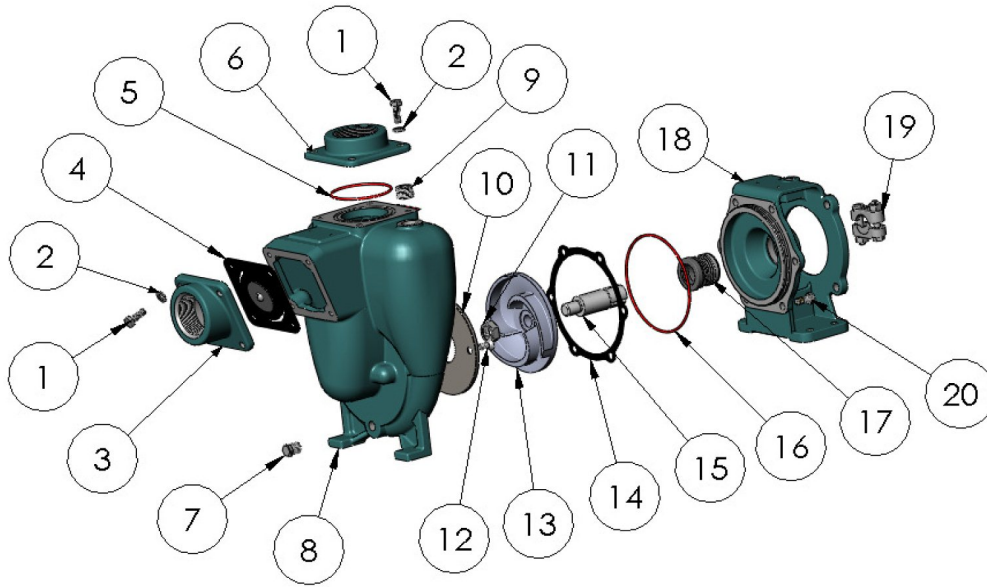

ITEM NO.	PART NO.	DESCRIPTION	QTY.		ITEM NO.	PART NO.	DESCRIPTION	QTY.
1	21242	CAPSCREW S.S. - 5/16"-18 X 7/8"	8		11	22655	JAM NUT S.S. - 5/8"-18	1
2	21238	LOCKWASHER S.S. - 5/16	10		12	37137	SCREW SS - 5/16"-18 X 5/8"	2
3	22387	SUCTION FLANGE C - 2" NPT	1		13	22293	IMPELLER C - Ø5.0	1
* 4	23022	FLAPPER ASSY - BUNA	1	*	14	22255	GASKET - NI-2085	1
* 5	37141	O-RING - VITON	1		15	25664	DRIVE SLEEVE S.S. - 7/8	1
6	22311	DISCHARGE FLANGE B - 2" NPT	1	*	16	34555	O-RING - VITON - AS-568-158	1
7	41475	PIPE PLUG STL. - 1/4" NPT	1	*	17	22272	SEAL ASSY. - T-2100 VITON	1
8	22251	HOUSING C	1		18	25904	ADAPTER C - CC MOTOR	1
9	37140	FILL PLUG ZPS - 1/2" NPT	1		19	33003	CLAMP ASSY. S.S. - 7/8 SL	2
* 10	22260	WEAR PLATE STL.	1		20	24965	CAPSCREW- 5/16"-18 X 3/4" - PATCH	6

* SUGGESTED REPLACEMENT PARTS