

SELF-PRIMING CENTRIFUGAL TRASH PUMP

Series: SH8-U

Suction: 8"

Discharge: 8"

Spherical solids handling: 3"



SIZE

8" x 8" NPT, 125 lbs., female flange.

LIQUID TEMPERATURE

160°F (71 °C)

CASING

Cast iron ASTM A-48 class 30. Maximum operating pressure 86 psi (593 KPa).

IMPELLER

Design: 2 vane, open.

Material: ductile iron no. 65-45-12.

SHAFT

Alloy Steel no. 4140.

SHAFT SLEEVE

316 series stainless steel.

WEAR PLATE

Carbon steel no. 1015. Replaceable.

COVER PLATE

Cast iron ASTM A-48 class 30, weight 37 lbs. Removable/adjustable.

FLAP VALVE

Neoprene with steel reinforcing.

BEARING HOUSING

Cast iron ASTM A-48 class 30.

SEAL PLATE

Cast iron ASTM A-48 class 30.

BEARING - PUMP END

Open single ball, radial load.

BEARING - DRIVE END

Open double ball, thrust load.

SEAL CAVITY AND BEARING LUBRICATION

SAE no. 30 non detergent oil, pump includes oil level sight gauges.

GASKETS

Buna-N, compressed synthetic fibers, PTFE, vegetable fiber, cork and rubber.

O-RINGS

Buna-N.

HARDWARE

Standard plated steel.

PAINT

Air dry enamel, water based.

PRESSURE RELIEF VALVE

Brass.

SEAL

Design: type 21, mechanical, oil lubricated, double floating, self aligning.

Material: silicon carbide rotating and stationary faces, fluorocarbon elastomers (Viton® or equivalent). 316 stainless steel cage and spring.

OPTIONAL EQUIPMENT

Flexible coupled assy, with base OSHA guard and electric motor.

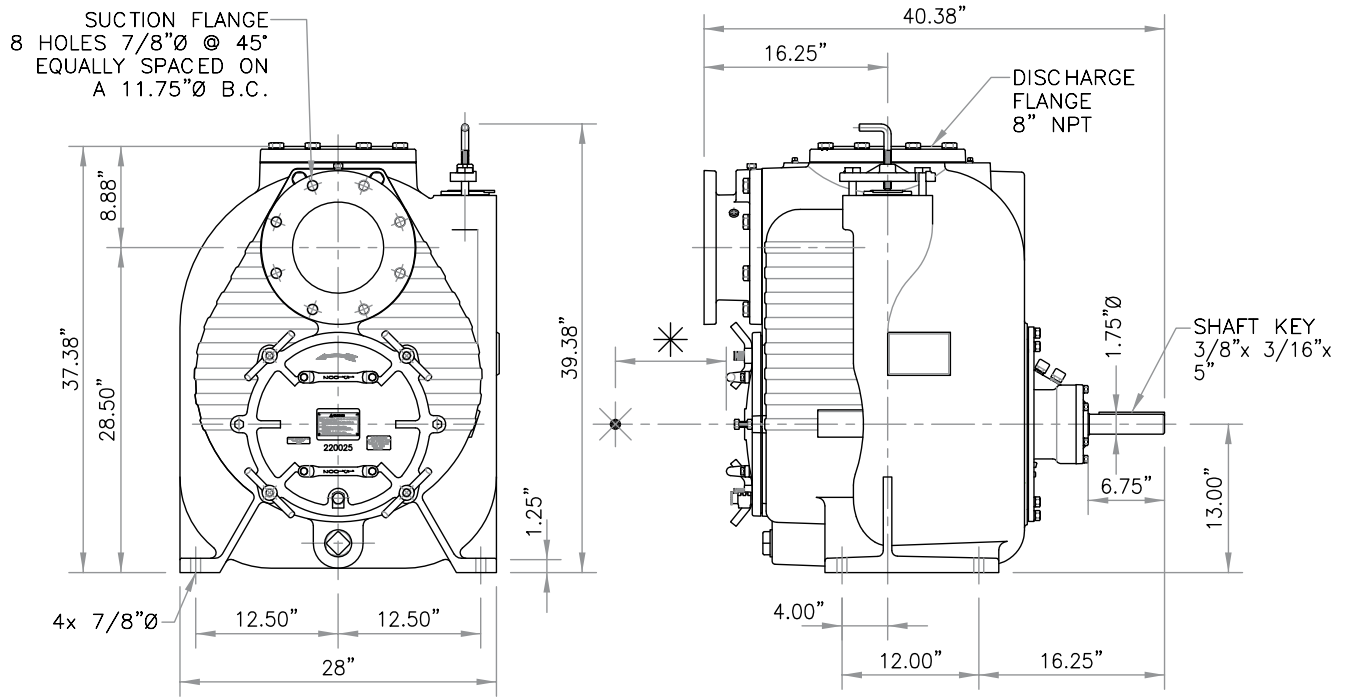

* 24" CLEARANCE RECOMMENDED FOR MAINTENANCE. 13" MINIMUM.



IMPORTANT! - Do not use in explosive atmosphere or for pumping volatile flammable liquids.

barmesapumps.com

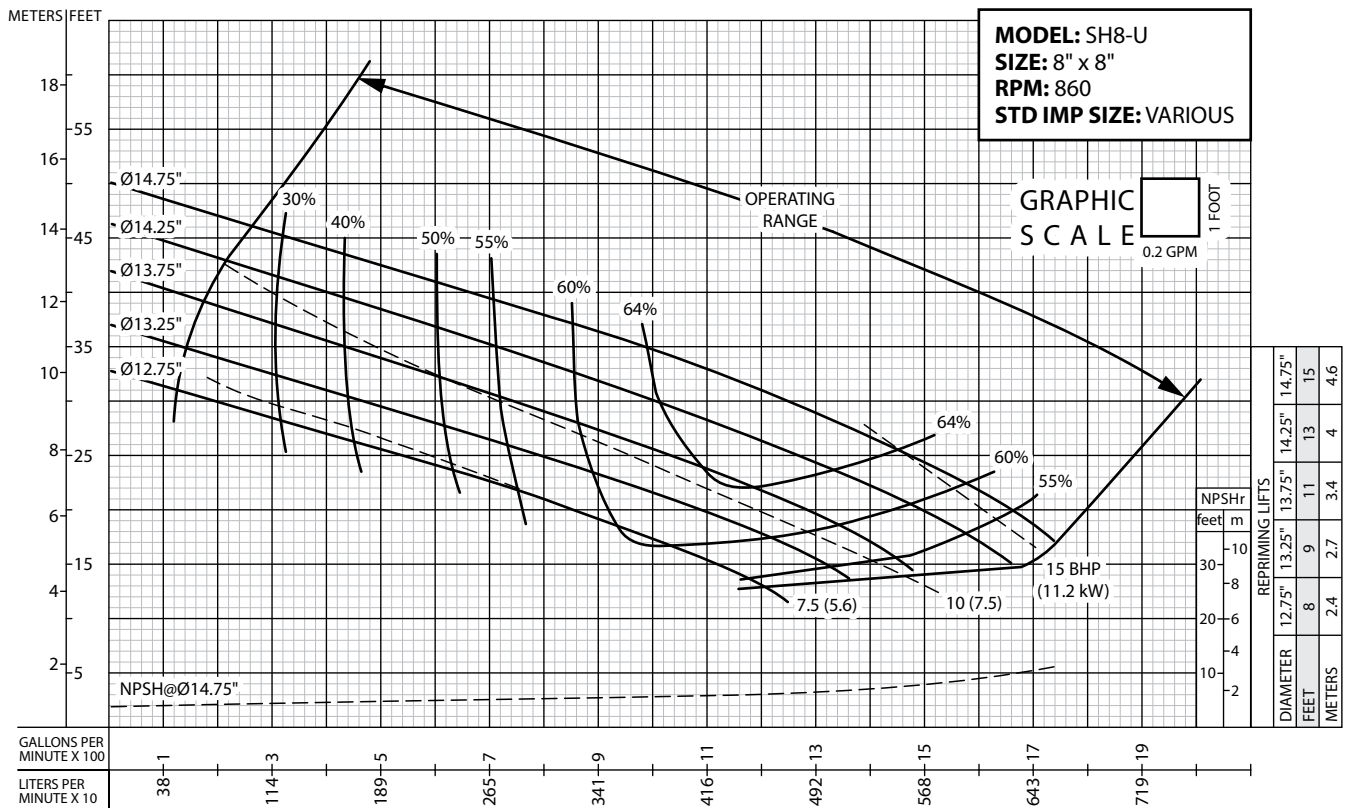
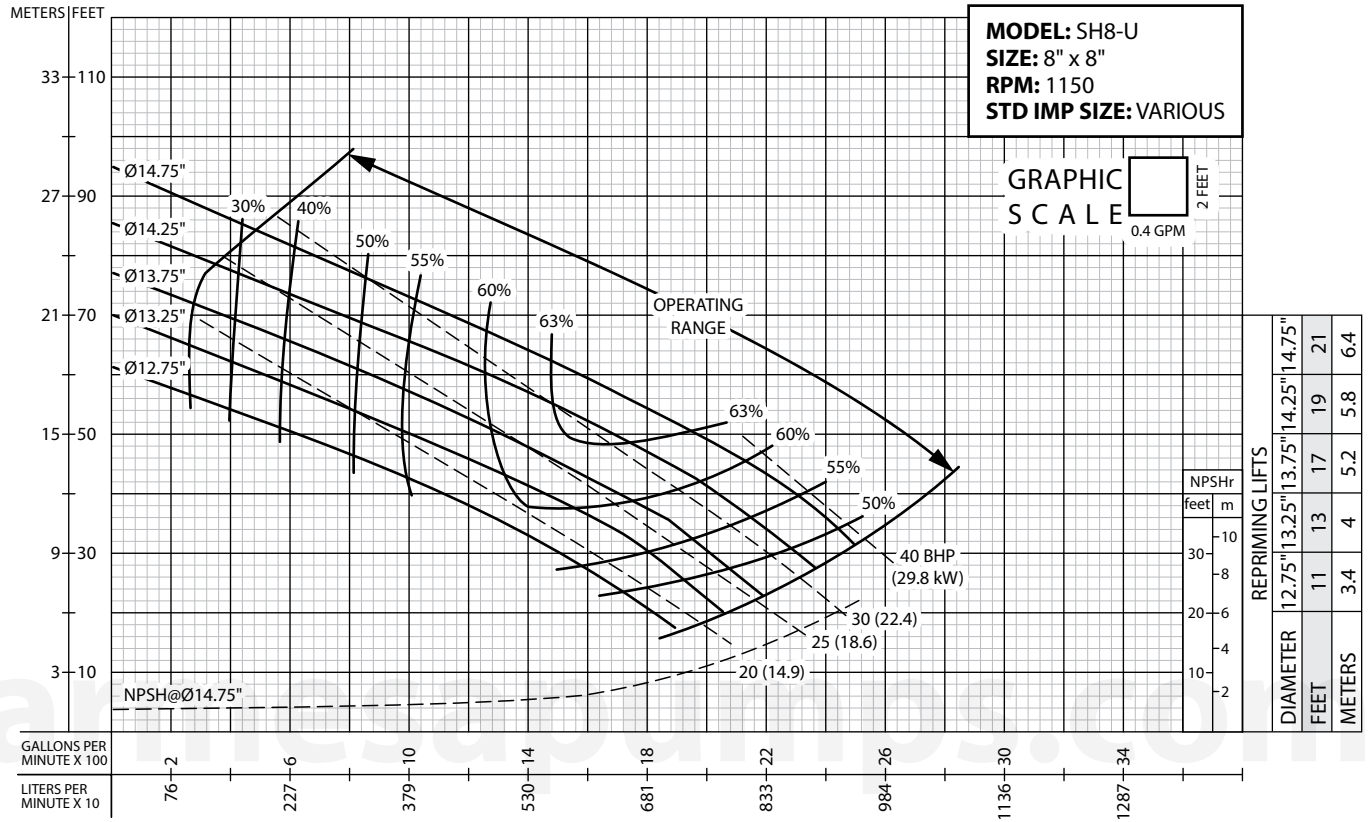

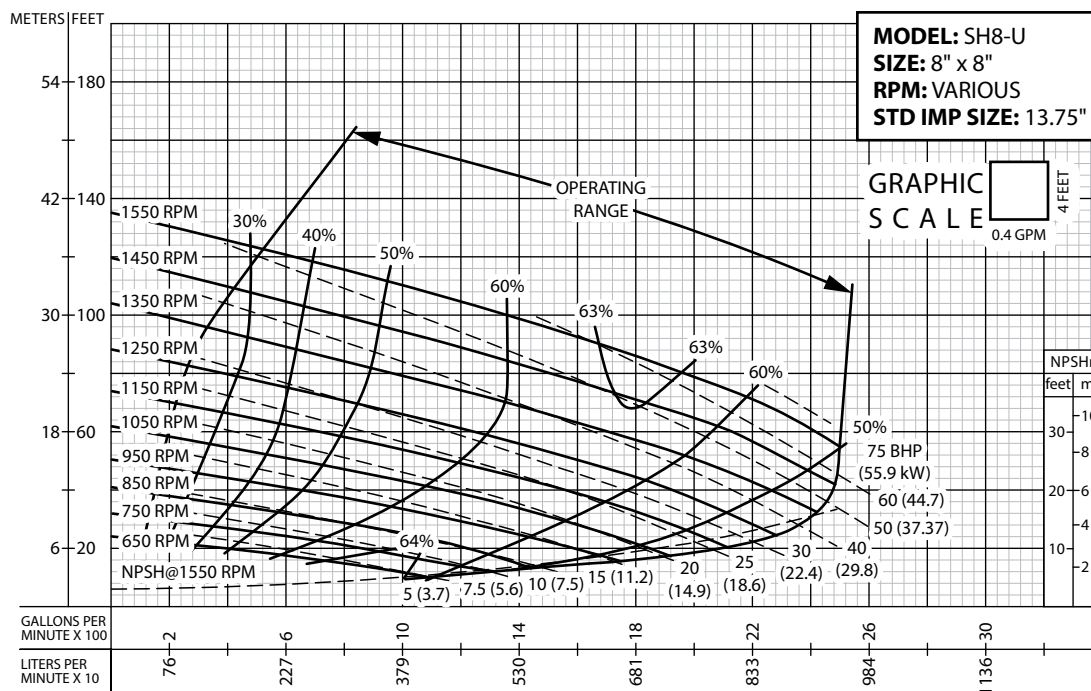
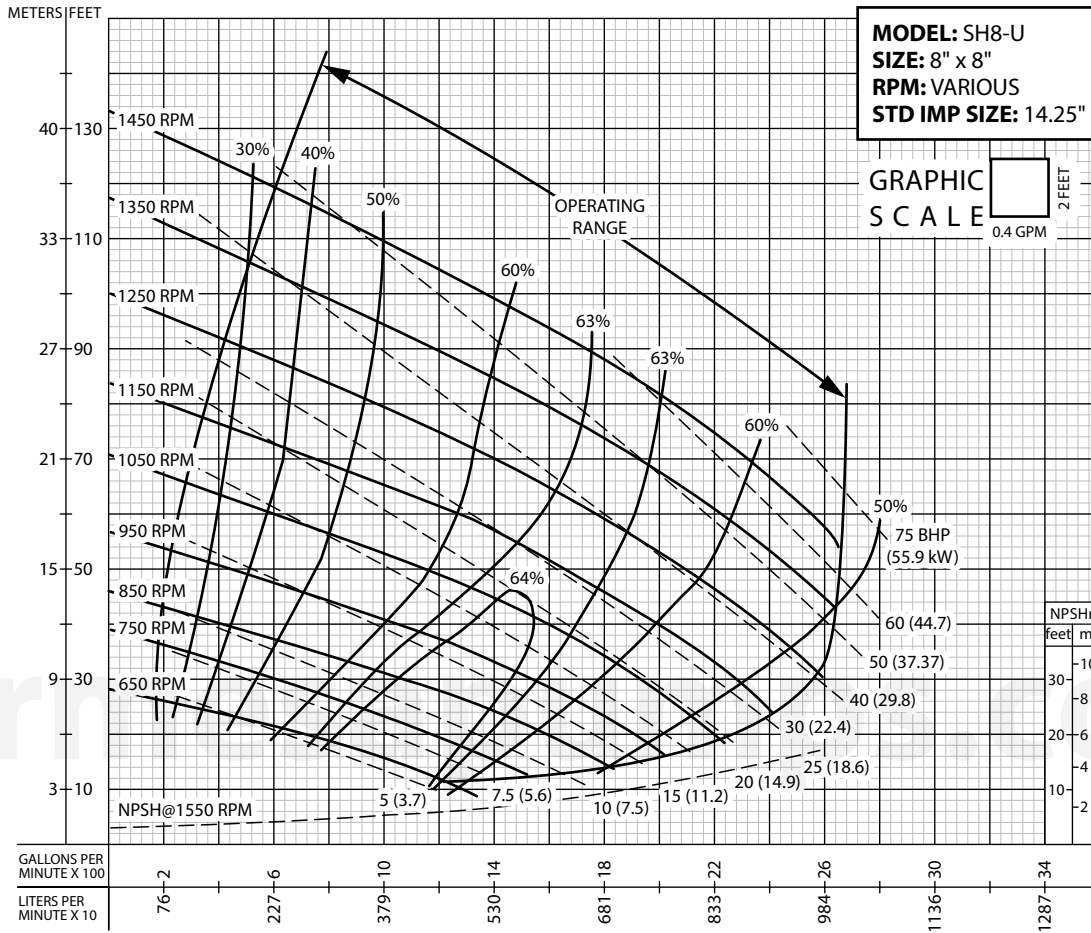

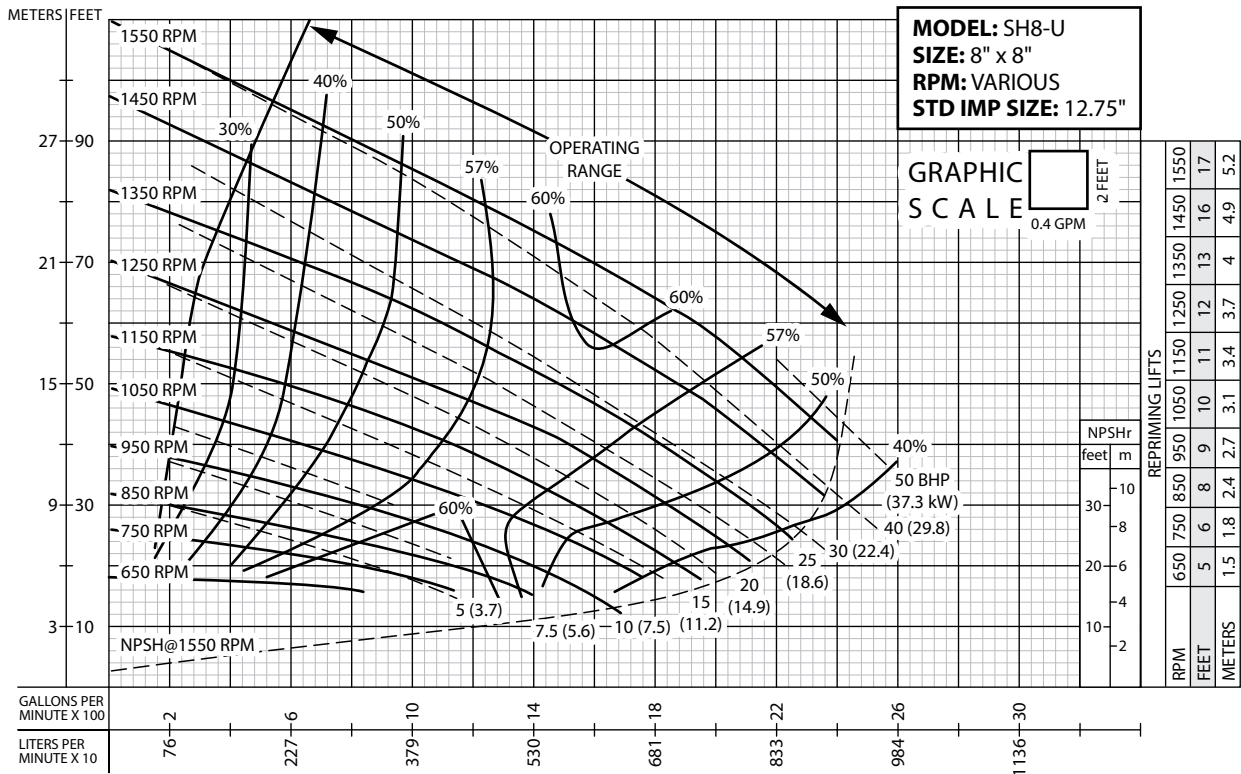
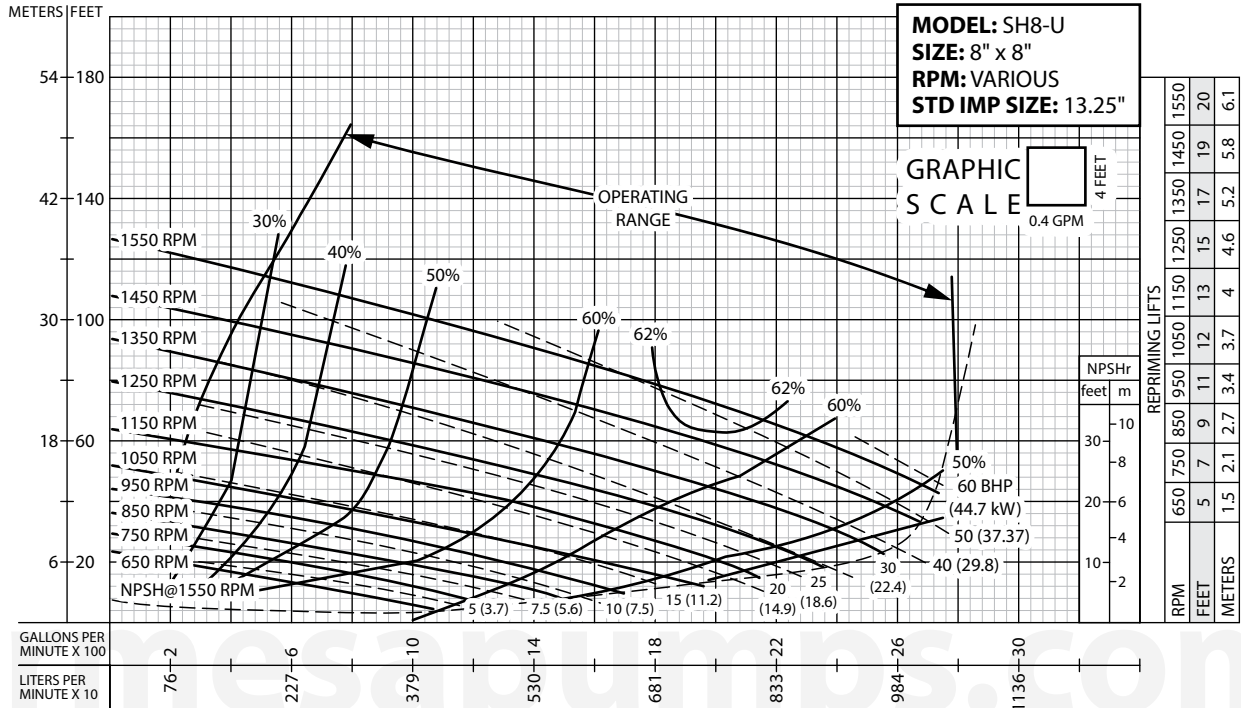

PERFORMANCE CURVE

Self-Priming Centrifugal Trash Pump

Series: SH8-U

