

# SELF-PRIMING CENTRIFUGAL TRASH PUMP

Series: SH3-U

Suction: 3"

Discharge: 3"

Spherical solids handling: 2½"



## SIZE

3"x3" NPT, 125 lbs., female flange.

## LIQUID TEMPERATURE

160°F (71 °C)

## CASING

Cast iron ASTM A-48 class 30. Maximum operating pressure 87 psi (600 KPa).

## IMPELLER

**Design:** 2 vane, open.

**Material:** ductile iron no. 65-45-12.

## SHAFT

Alloy Steel no. 4140.

## SHAFT SLEEVE

316 series stainless steel.

## WEAR PLATE

Carbon steel no. 1015. Replaceable.

## COVER PLATE

Cast iron ASTM A-48 class 30, weight 30 lbs. Removable/adjustable.

## FLAP VALVE

Neoprene with steel reinforcing.

## BEARING HOUSING

Cast iron ASTM A-48 class 30.

## SEAL PLATE

Cast iron ASTM A-48 class 30.

## BEARING - PUMP END

Open single ball, radial load.

## BEARING - DRIVE END

Open double ball, thrust load.

## SEAL CAVITY AND BEARING LUBRICATION

SAE no. 30 non detergent oil, pump includes oil level sight gauges.

## GASKETS

Buna-N, compressed synthetic fibers, PTFE, vegetable fiber, cork and rubber.

## O-RINGS

Buna-N.

## HARDWARE

Standard plated steel.

## PAINT

Air dry enamel, water based.

## PRESSURE RELIEF VALVE

Brass.

## SEAL

**Design:** type 21, mechanical, oil lubricated, double floating, self aligning.

**Material:** silicon carbide rotating and stationary faces, fluorocarbon elastomers (Viton® or equivalent). 316 stainless steel cage and spring.

## OPTIONAL EQUIPMENT

Flexible coupled assy, with base OSHA guard and electric motor.

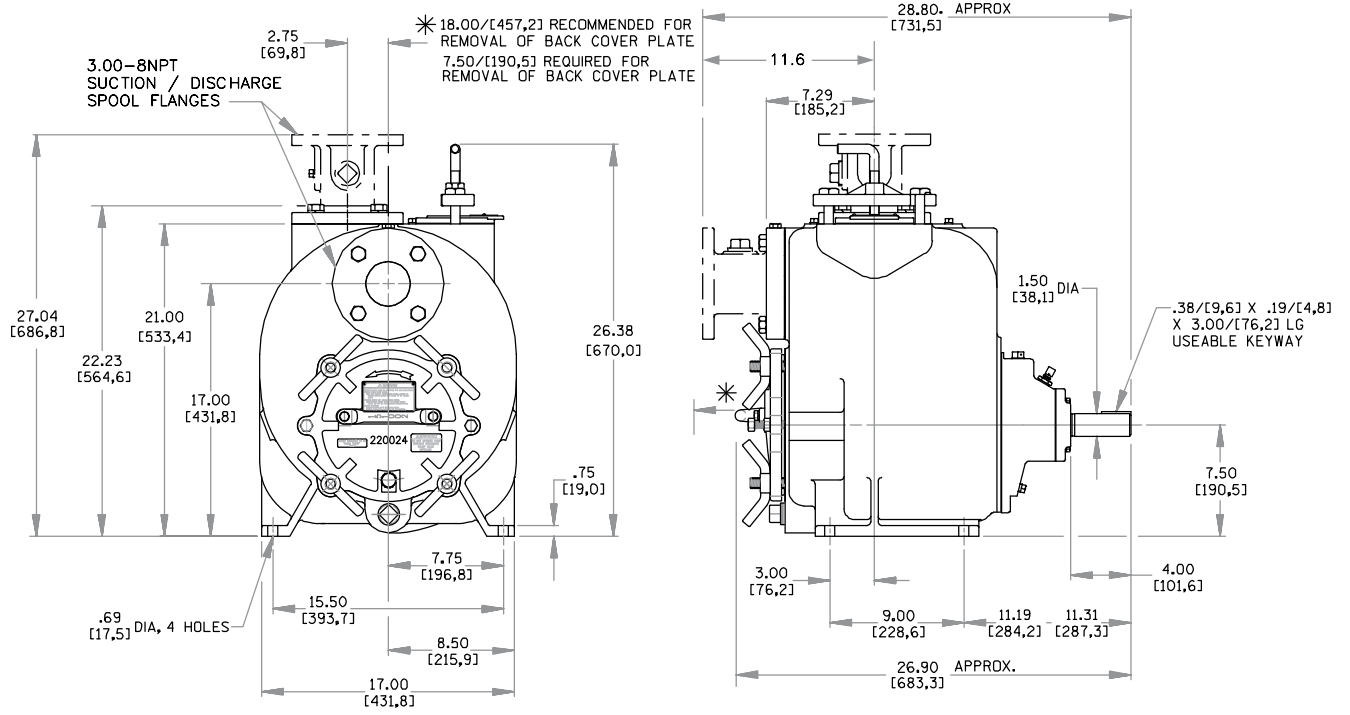

**IMPORTANT! - Do not use in explosive atmosphere or for pumping volatile flammable liquids.**

barmesapumps.com

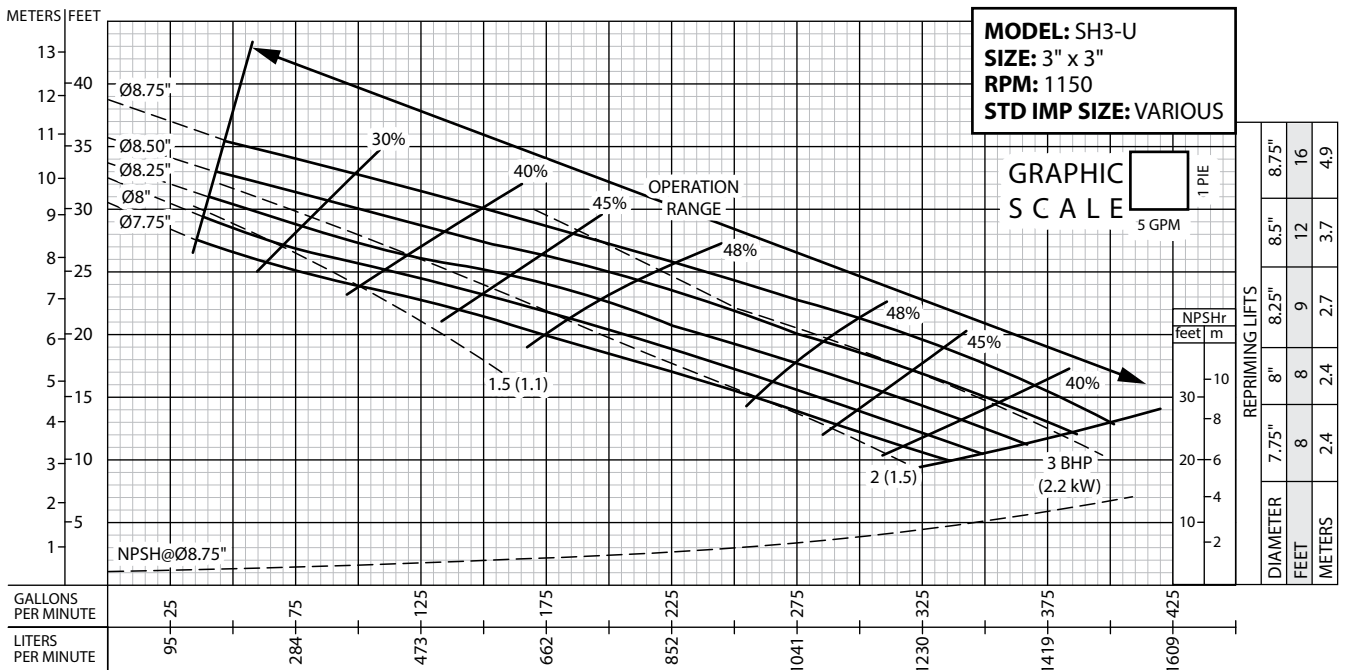
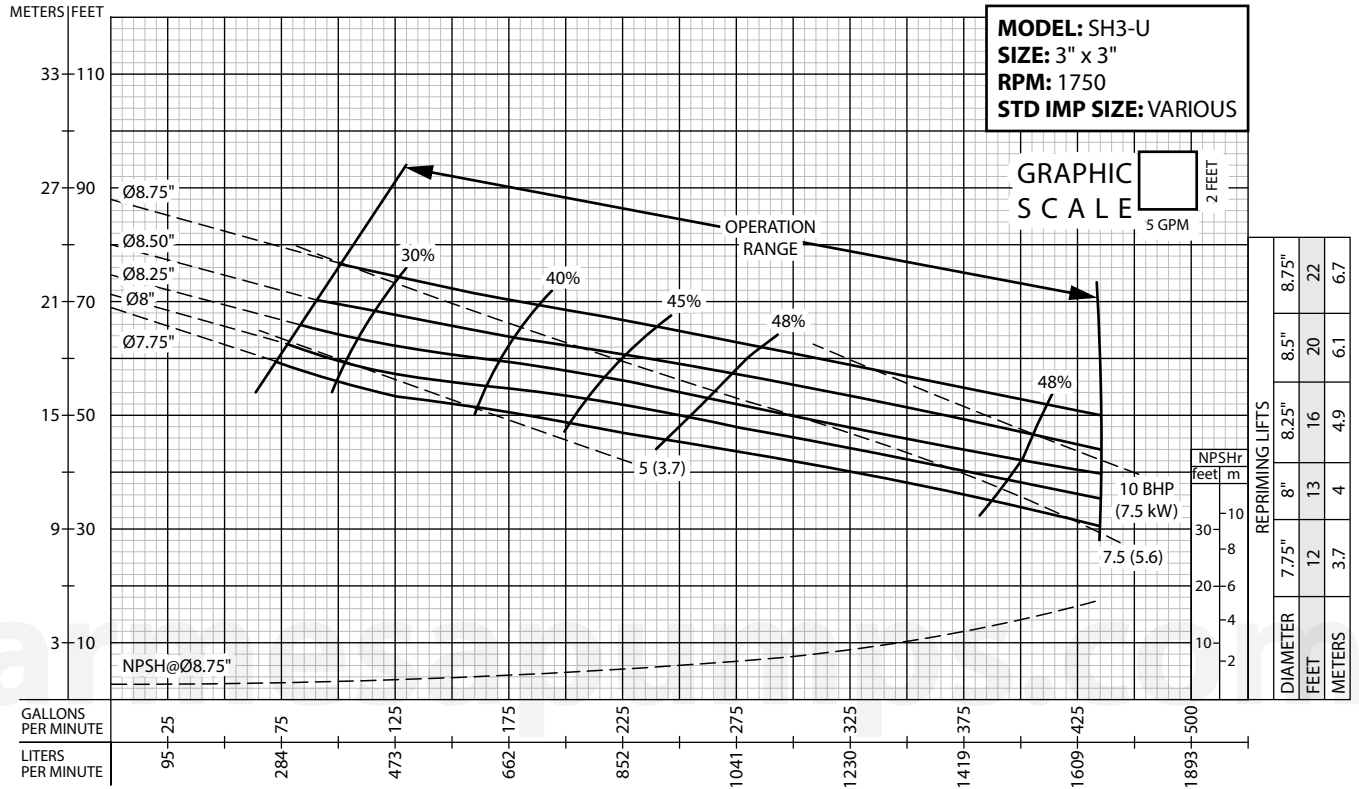

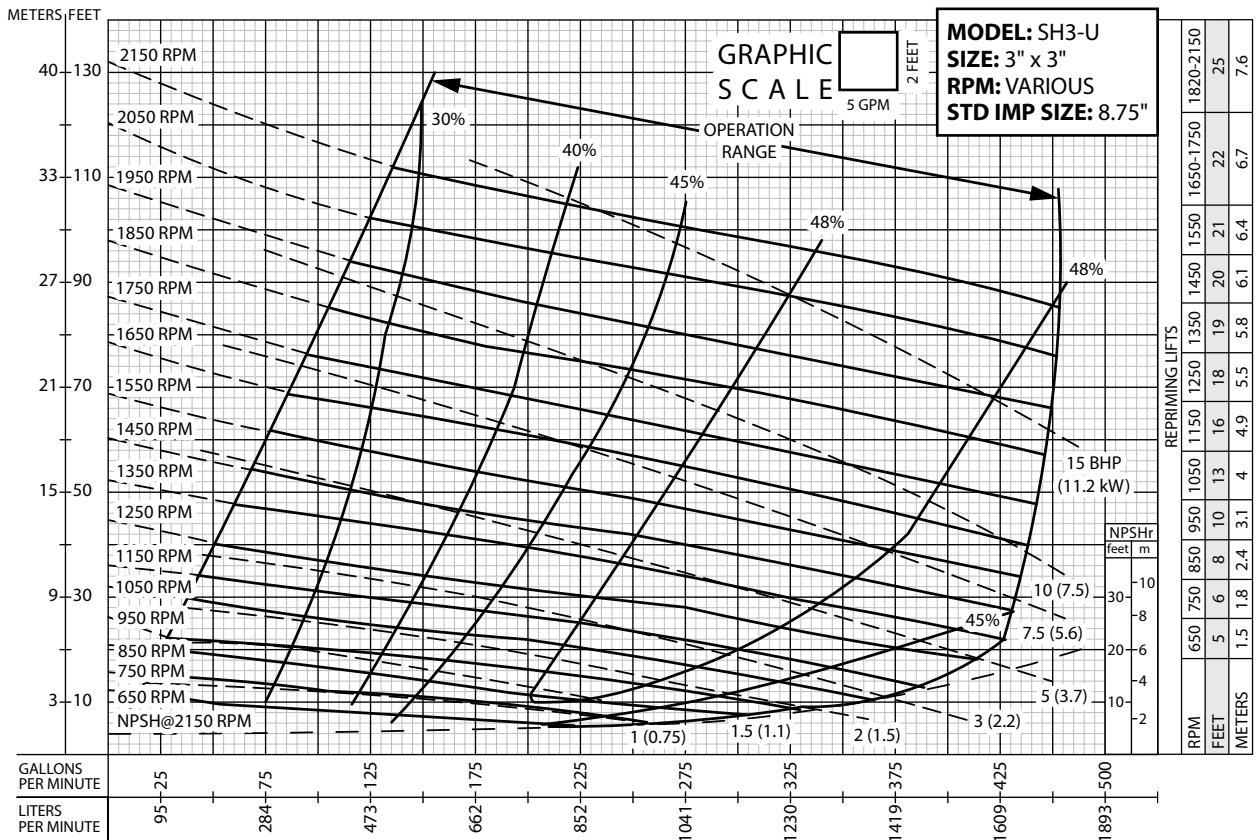
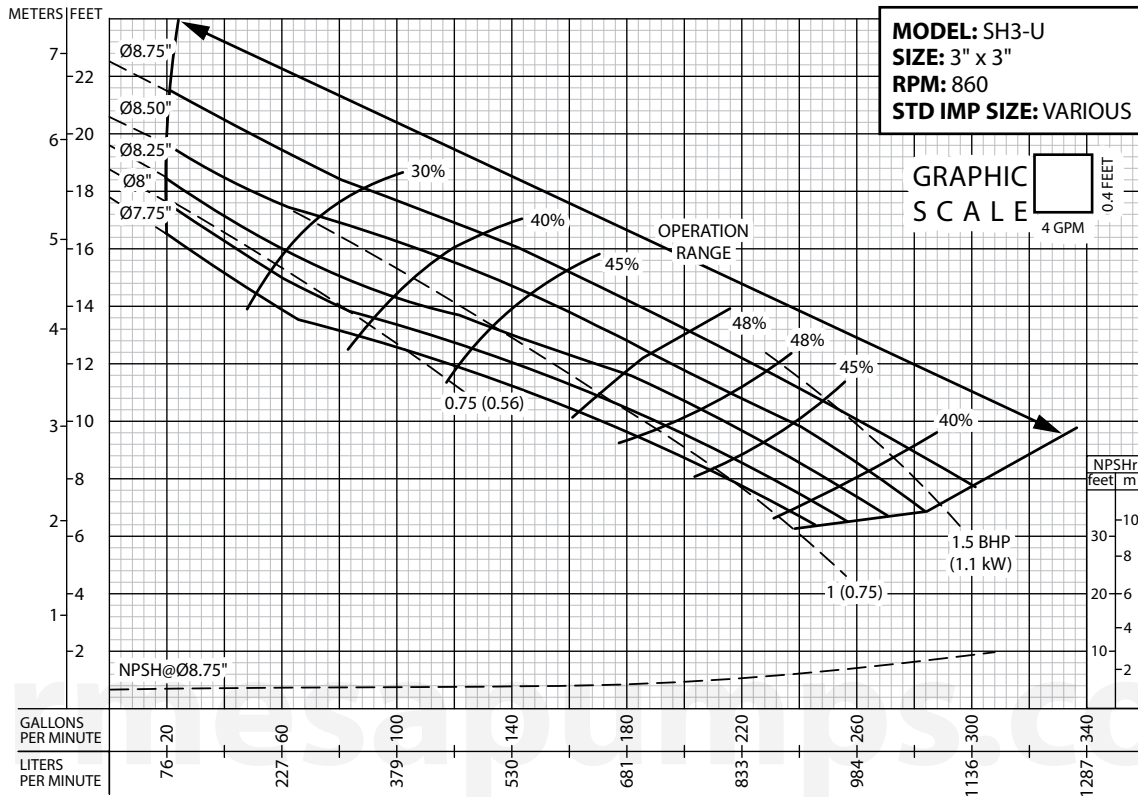

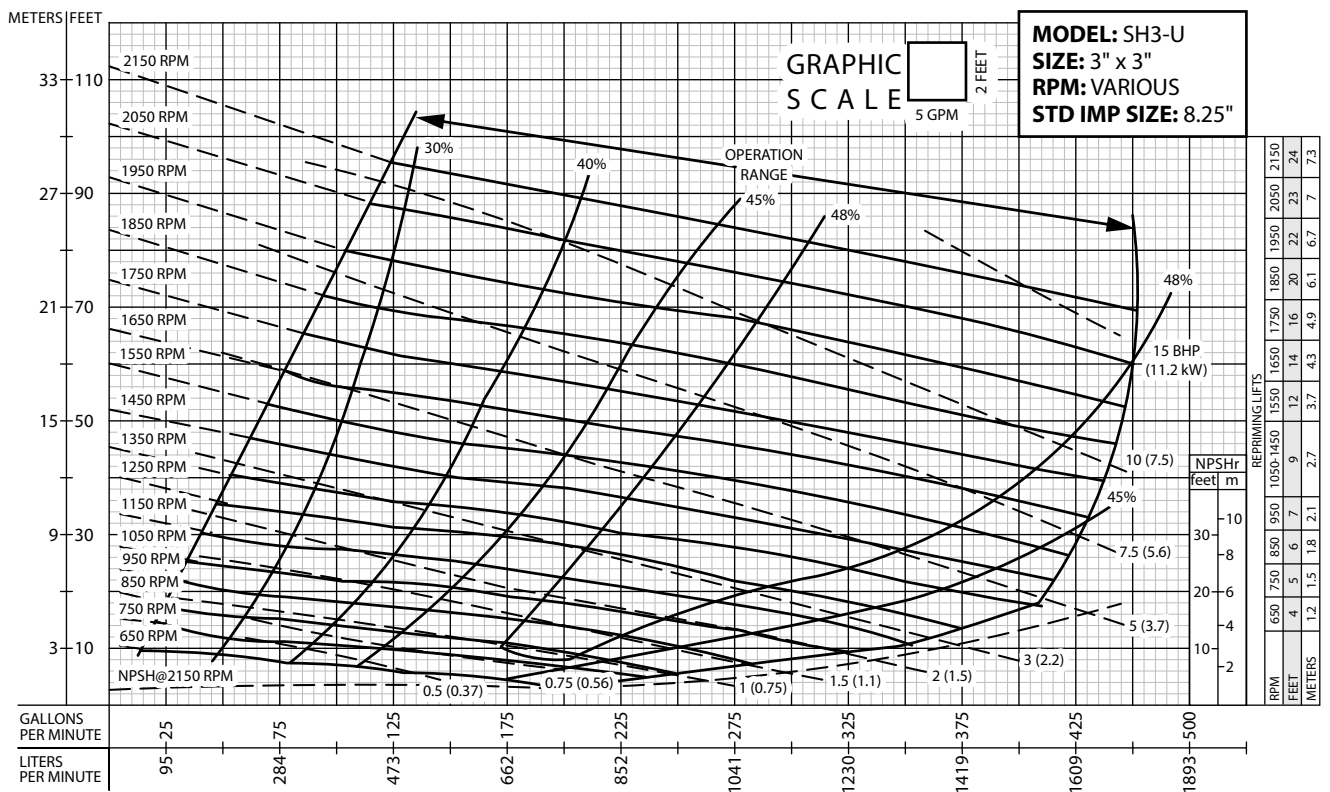
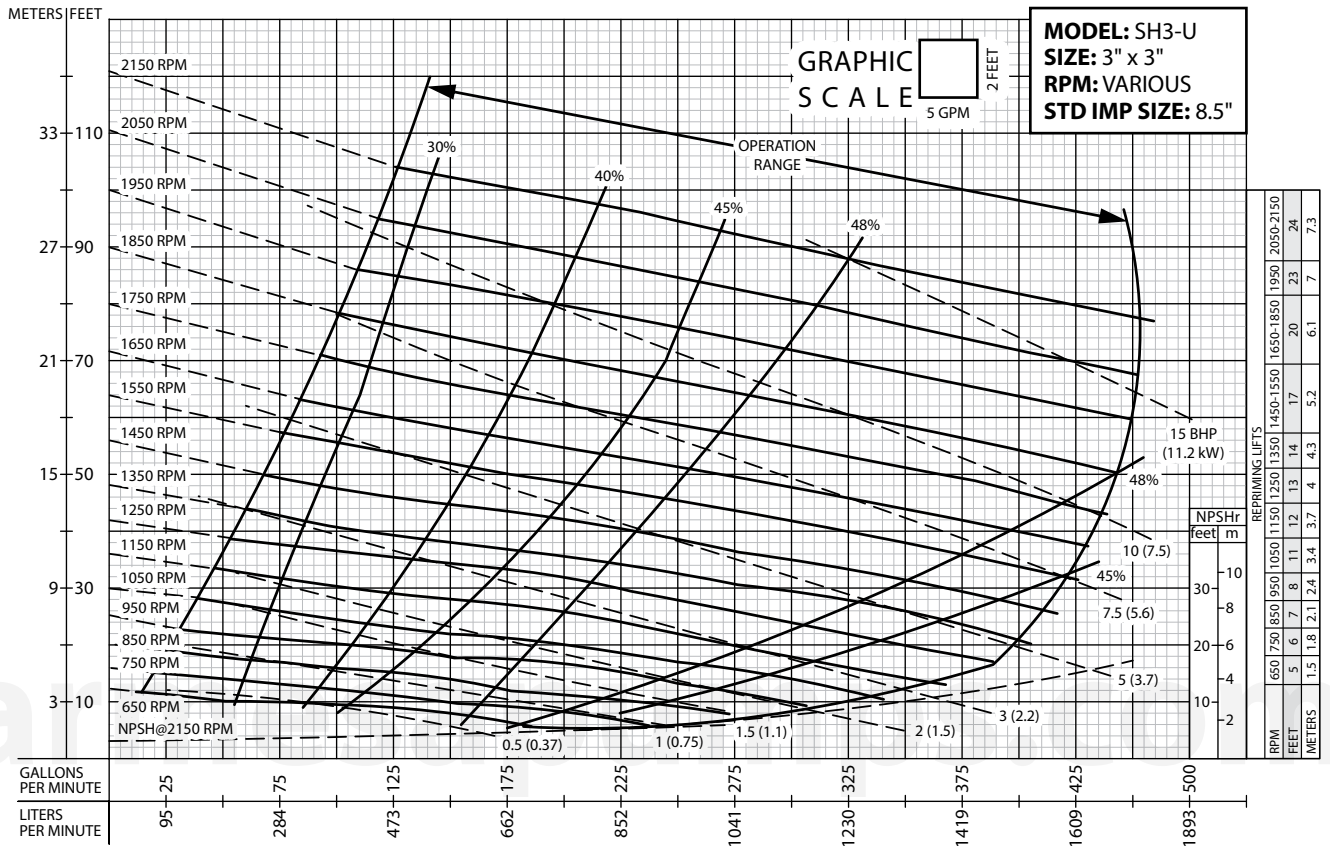

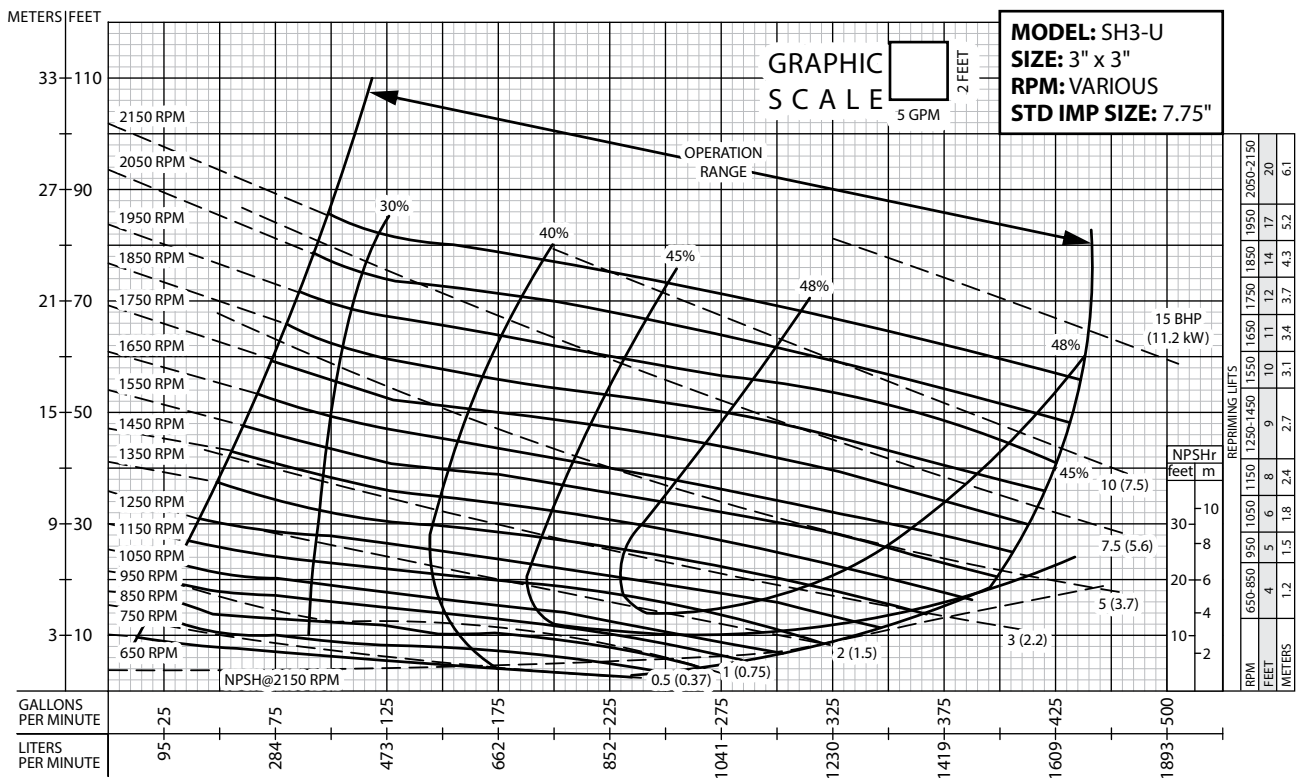
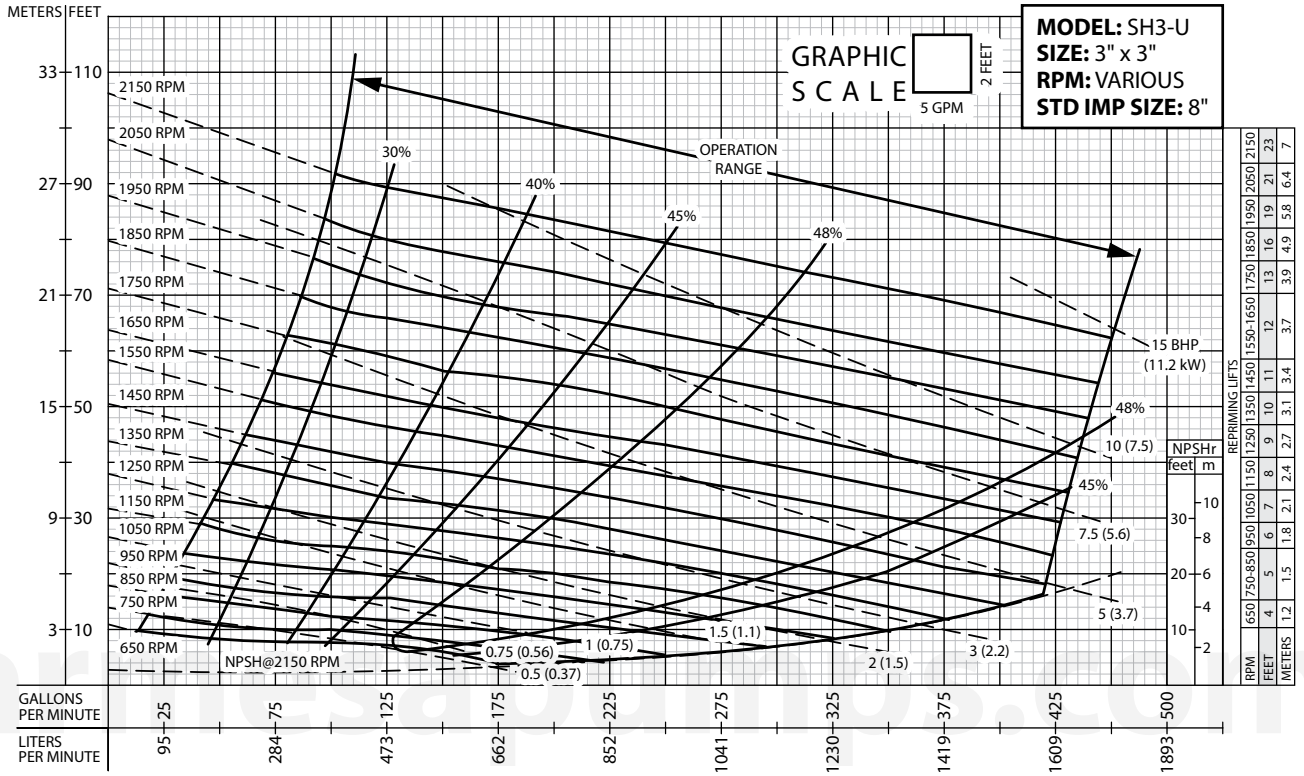

# PERFORMANCE CURVE

## Self-Priming Centrifugal Trash Pump

### Series: SH3-U

