

Heavy Duty Centrifugal Pumps



High Head Pump



High Flow Pump

- **Available in: 300 Series Investment Cast Stainless Steel, Cast Bronze and Cast Iron Construction with Stainless Steel Impeller**
- **Buna-N Mechanical Seal and O-Ring on Cast Iron Models**
- **Viton® Mechanical Seal and O-Ring on Stainless Steel and Bronze Models**
- **Optional Silicon Carbide Seals Available**
- **Front Drain Plugs Located 90° Apart**
- **Maximum Head 194 Feet (84 PSI)**
- **Maximum Flow 500 GPM**
- **2 HP to 15 HP NEMA Motors, Single and Three Phase**
- **Optional Mounting Base Available**
- **Solids Handling and Dirty Water Design**

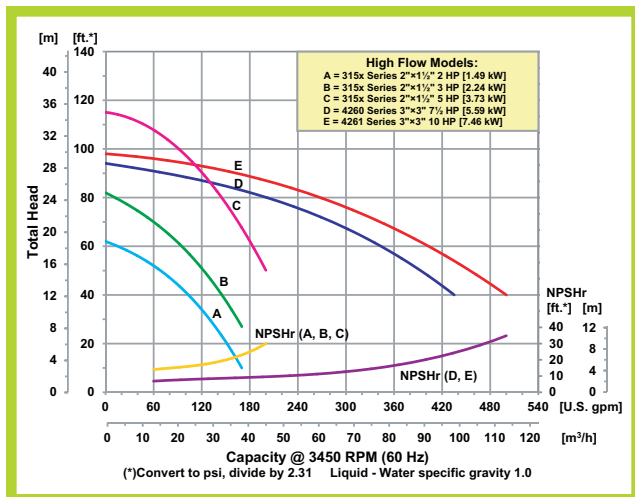
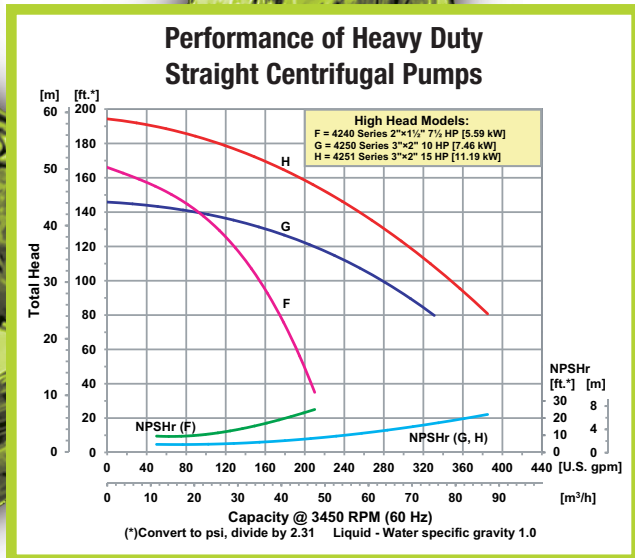

AMT Heavy Duty Solids Handling Centrifugal pumps are suited for liquid and chemical transfer, recirculation, booster service, dirty water and other industrial applications. Stainless steel units are especially effective in applications where rust and/or corrosion can develop in systems. Pumps are designed to handle liquids with solids content or dissolved solids and debris. Semi-open impeller features self-cleaning ability that makes the unit useful in applications involving up to 1/4" diameter solids and muddy or dirty liquids. Discharge position can be adjusted in 90° increments with vent and drain plugs for all positions. Type 21 mechanical seal and O-ring casing seal. **Pumps are not self-priming and require flooded suction.**



400 Spring Street • Royersford, PA 19468 USA

www.amtpump.com • 888-amt-pump (268-7867)

For use with nonflammable liquids compatible with pump component materials. Viton® and Teflon® are registered trademarks of E. I. DuPont.

Pump Dimensional & Specification Data

Model ‡	Curve	HP	PH	Frame	ENC	Voltage @ 60 Hz +	Full Load Amps	SUC*	DIS*	A**	B**	C**	D**	E	F**	G	J**	K	L**	W**	H	‡ Ship Wt. (Lbs.)
3156			1	56J		115/230	22/11			5.4 [13.8]	5.0 [12.7]	8.5 [21.8]	3.5 [8.9]	2.5 [6.4]	4.0 [10.2]	4.3 [11.0]	2.4 [6.2]	1.3 [3.5]	17.4 [44.2]	10.6 [26.9]	9.6 [24.4]	78
3150	A	2	3	145JM	TEFC	230/460	6/3	2	1½	6.1 [15.5]	3.5 [8.9]	10.7 [27.1]	3.5 [8.9]	2.5 [6.4]	4.0 [10.2]	4.4 [11.3]	2.7 [7.0]	1.3 [3.5]	19.2 [48.7]	11.4 [28.9]	9.6 [24.4]	84
3157			3	56J		230/460	6/3			5.4 [13.8]	3.6 [9.1]	8.5 [21.8]	3.5 [8.9]	2.5 [6.4]	4.0 [10.2]	4.3 [11.0]	2.4 [6.2]	1.3 [3.5]	16.9 [42.9]	10.6 [26.9]	9.6 [24.4]	71
315A			1	56J		230	12			5.4 [13.8]	5.0 [12.7]	8.6 [21.8]	3.5 [8.9]	2.5 [6.4]	4.0 [10.2]	4.3 [11.0]	2.4 [6.2]	1.3 [3.5]	17.9 [45.4]	10.6 [26.9]	9.6 [24.4]	87
3151	B	3	3	182JM	TEFC	230/460	8/4	2	1½	7.1 [18.0]	6.6 [16.8]	10.9 [27.6]	4.5 [11.4]	2.5 [6.4]	4.0 [10.2]	4.4 [11.3]	3.7 [9.5]	0.3 [0.9]	20.0 [50.8]	12.8 [32.5]	9.6 [24.4]	137
315B			3	56J		230/460	8/4			5.4 [13.8]	3.6 [9.1]	8.5 [21.8]	3.5 [8.9]	2.5 [6.4]	4.0 [10.2]	4.3 [11.0]	2.4 [6.2]	1.3 [3.5]	17.4 [44.2]	10.6 [26.9]	9.6 [24.4]	75
315E			1	184JM		230	16			7.8 [19.9]	6.6 [16.8]	10.8 [27.6]	4.5 [11.4]	2.5 [6.4]	4.0 [10.2]	4.4 [11.3]	3.7 [9.5]	0.3 [0.9]	24.2 [61.4]	13.9 [35.3]	9.6 [24.4]	143
3152	C	5	3	184JM	TEFC	230/460	17/9	2	1½	7.1 [18.0]	6.6 [16.8]	10.8 [27.6]	4.5 [11.4]	2.5 [6.4]	4.0 [10.2]	4.4 [11.3]	3.7 [9.5]	0.3 [0.9]	21.7 [55.1]	12.8 [32.5]	9.6 [24.4]	145
4264			1	213JM		230	32			9.0 [22.9]	7.3 [18.7]	12.3 [31.4]	5.2 [13.3]	2.7 [7.0]	4.5 [11.4]	4.7 [12.1]	4.2 [10.8]	0.2 [0.7]	27.0 [68.6]	16.2 [41.1]	12.0 [30.4]	205
4260	D	7½	3	184JM	TEFC	230/460	22/11	3	3	7.0 [18.0]	6.6 [16.8]	11.6 [29.5]	4.5 [11.4]	2.7 [7.0]	4.5 [11.4]	4.7 [12.1]	3.7 [9.5]	1.0 [2.6]	22.5 [57.1]	14.3 [36.3]	12.0 [30.4]	172
4265			1	215JM		230	40			9.0 [22.9]	6.2 [15.7]	12.3 [31.4]	5.2 [13.3]	2.7 [7.0]	4.5 [11.4]	4.7 [12.1]	4.2 [10.8]	0.2 [0.7]	27.0 [68.5]	16.2 [41.1]	12.0 [30.4]	213
4261	E	10	3	215JM	TEFC	230/460	26/13	3	3	8.1 [20.7]	7.3 [18.7]	12.3 [31.4]	5.2 [13.3]	2.7 [7.0]	4.5 [11.4]	4.7 [12.1]	4.2 [10.8]	0.2 [0.7]	26.0 [66.0]	15.0 [38.1]	12.0 [30.4]	204
4242			1	213JM		230	32			9.0 [22.9]	7.3 [18.7]	11.3 [28.9]	5.2 [13.3]	2.4 [6.2]	3.8 [9.7]	4.4 [11.3]	4.2 [10.8]	N/A	26.0 [66.0]	14.6 [37.1]	11.1 [28.1]	196
4240	F	7½	3	184JM	TEFC	230/460	22/11	2	1½	7.1 [18.0]	6.6 [16.8]	10.6 [27.0]	4.5 [11.4]	2.4 [6.2]	4.5 [11.4]	4.5 [11.4]	3.7 [9.5]	0.1 [0.3]	21.5 [54.6]	12.6 [32.0]	10.5 [30.6]	163
4253			1	215JM		230	40			9.0 [22.9]	5.5 [14.2]	11.5 [29.3]	5.2 [13.3]	2.7 [7.1]	4.7 [12.1]	5.0 [12.9]	4.2 [10.8]	0.3 [0.9]	26.1 [66.3]	15.9 [40.4]	10.6 [26.9]	217
4250	G	10	3	215JM	TEFC	230/460	26/13	3	2	8.1 [20.7]	7.3 [18.7]	11.5 [29.3]	5.2 [13.3]	2.7 [7.1]	4.7 [12.1]	5.0 [12.9]	4.2 [10.8]	0.3 [0.9]	25.2 [64.0]	14.7 [37.3]	10.6 [26.9]	208
4251	H	15	3	215JM	TEFC	230/460	47/24	3	2	8.1 [20.7]	7.3 [18.7]	11.5 [29.3]	5.2 [13.3]	2.7 [7.1]	4.7 [12.1]	5.0 [12.9]	4.2 [10.8]	0.3 [0.9]	25.2 [64.0]	14.7 [37.3]	10.6 [26.9]	218

(*) Standard NPT (Female) pipe thread.

(**) This dimension may vary due to motor manufacturer's specifications.

(+) 3-Phase motors can also operate on 50 Hz. (This will change full load amps, service factor and RPM)

NOTE: Dimensions are in inches (centimeters) and have a tolerance of ± 1/4".

NOTE: Electric supply for ALL motors must be within ±10% of nameplate voltage rating (e.g. 230V ±10%= 207 to 253).

NOTE: Check Price Book for Specific Pump Construction/Material Availability.
Maximum Solids Handling Capacity: 1/4" Diameter

‡ When Ordering, Add the Correct

(-9X) Suffix to Model Number Indicating Material Selection (Ex. 315A-95)

XCI (-95) Cast Iron Construction with Buna-N Seals

XB (-94) Cast Bronze Construction with Viton® Seals

XSS (-98) Cast Stainless Steel Construction with Viton® Seals

(All Models Come Standard with Stainless Steel Impeller)

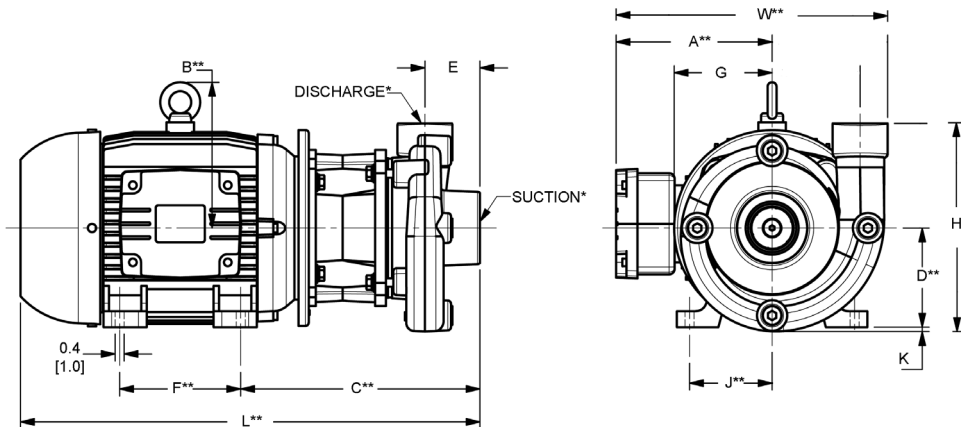

Standard Features

- Stainless Steel, Bronze and Cast Iron Construction
- Buna-N or Viton® Mechanical Seal and O-ring, Depending on Model
- Optional Silicon Carbide Mechanical Seals Available
- Stainless Steel Motor Shaft and Hardware
- NEMA TEFC Single and Three Phase Motors, Depending on Model
- Optional Mounting Base Available for 182/184/215 JM Frames
- Self-cleaning Stainless Steel Impeller
- Maximum Working Pressure 150 PSI
- Maximum Temperature
 - ♦ Viton® 200° F
 - ♦ Buna-N 180° F
- Optional Seal Wash Port and Hose Available on All Models
- Pedestal Version Models Available for Frame Models 145/182/184JM
- QSP – Quick Ship Pump for Many Models
- Solids Handling Design

Hazardous Duty/Xplosion Proof motors available from stock ranging from 1 to 10 HP; CALL FOR QUOTATION & LEAD TIME!